

STONE TOOLING

LISTE DE PRIX

 **DIAMUT**

LISTE DE PRIX

INDICE

KPL LIGNE.....	9
INFORMACIÓN TÉCNICA.....	10
Tabla de granos diamantada	10
Descripción de la meula diamantada	10
Información dimensional	11
Information matériel	11
FORÊTS	12
Forêt segmenté.....	12
Forêt couronne continue.....	12
Forêt trou borgne granit L1-55.....	13
Forêt trou borgne granit L1-40.....	13
Ligne black storm	14
Or-haute durée.....	14
Vert.....	15
Bleu.....	15
Electrodépot	15
Fraise pour granit diamètre 24mm	16
Fraise vacuum brazed.....	16
Pastilles pour la coupe en passe	16
Support avec fixation 1/2" GAS pour les pastilles de coupe passées.....	17
Supports pour cône ISO 40 pour les pastilles de coupe passées	17
FORÊTS GAUCHE (SX).....	18
Forêt couronne continue.....	18
PASTILLE POUR LA COUPE EN PASSE A GAUCHE.....	19
Pastilles pour la coupe en passe	19
Support avec fixation 1/2" GAS pour les pastilles de coupe passées gauche	19
FRAISE DE COUPE AVEC ATTAQUE A GAUCHE.....	20
Ligne black storm	20
Or-haute durée.....	20
Vert.....	20
Bleu.....	21
Electrodépot	21
MEULE DE CALIBRAGE.....	22

MEULE D'ÉBAUCHE CORNER BREAKERS.....	23
Meule casse aretes a secteur profil X.....	23
Meules casse aretes a secteur profil Y.....	23
WHEELS FOR EDGE PROFILING – KPL LINE.....	24
La gamme de produits KPL: innovant, polyvalent et efficace.....	24
La nouvelle gamme de roues périphériques produites à Diamut a été développée pour répondre aux besoins du marché en pleine croissance. C'est l'évolution technologique parfaite de la gamme Standard Diamut. Convient supervisé les machines à commande numérique.e new.....	24
Utilisation recommandée pour les meules métalliques.....	26
Utilisation recommandée pour les meules Flash Polissage.....	27
Meules diamètre 120 mm.....	28
<i>Parametres de travail –KPL:</i>	29
Meules diamètre 80 mm.....	45
<i>Parametres de travail –KPL:</i>	45
Meules diamètre 60 mm.....	54
<i>Parametres de travail –KPL:</i>	54
Meules diamètre 40 mm.....	57
<i>Parametres de travail –KPL:</i>	57
MEULE POUR INTÉRIEUR DE CUVE Diamètre 20 mm – ½ GAS.....	61
<i>Parametres de travail:</i>	61
SMOAUTRE.....	67
Position extra enlèvement lignes.....	67
MEULE PÉRIPHÉRIQUE POUR MARBRE.....	68
et polissante pour marbre.....	68
Diameter 120 mm.....	69
<i>Parametres de travail:</i>	69
DIAMUT GRINDER.....	72
CHANT DROIT.....	73
Meule diamant pour chanfreins.....	73
Entretoise pour meules chanfreins.....	73
Support pour montage opposee.....	74
PLAN DU TRAVAIL.....	75
Sequenza di lavorazione.....	75
Set universel pour granit materil synthetique avec angle 60°.....	76
Set granit avec angle 60°.....	77
RAINURES.....	79
Fraise pour rainures cannelures 10mm attache 1/2" gas.....	79

Fraise pour rainures cannelures 12mm attache 1/2" gas	79
Fraise pour rainures cannelures 14mm attache 1/2" gas	80
Fraise pour rainures cannelures 20mm attache 1/2" gas	80
Meules d'incisions pour rainures eggoutoirs diamètre 140mm - INTERMAC (1F1).....	80
Meules d'incisions pour rainures eggoutoirs diamètre 150mm - BIMATECH (1F1).....	81
Meules d'incisions pour rainures eggoutoirs diamètre 180mm - BIMATECH (1F1).....	81
Incision V (Tile).....	81
Mitre 45.....	82
MEULE D'ÉBAUCHE.....	82
Meule d'ébauche pour gros enlèvement granit et synthétique.....	82
Meule d'ébauche secteur pour granit et synthétique.....	83
Meule d'ébauche Viper pour granit et synthétique.....	83
Meule d'ébauche secteur pour granit tendre et pierre abrasive	84
Meule d'ébauche pour gros enlèvement marbre	84
Meule d'ébauche électrodépot marbre.....	85
Extensions pour meules a décaissé.....	85
OUTILS DE DESSIN.....	87
Pointe a dessin PCD.....	87
Outils de dessin en PCD	87
Outils de gravure en PCD	88
OUTILS POUR INCISION ET ÉCRITURE.....	89
Pointe a gravure sur marbre - diamant électrodéposé.....	89
OUTILS POUR BISEAUX	92
Boisseaux V0 - Intermac	92
Boisseaux V3 - Intermac	92
Boisseaux V7 - diamètre 100 - Intermac.....	93
MEULE POUR FUNÉRAIR.....	94
Rouleau L170 - ISO40 Intermac.....	94
Rechange meule.....	94
Rouleau L65.....	95
Rechange meule.....	95
OUTILS POUR USINAGE INTÉRIEUR DE CUVE.....	96
Pour granit avec cône de potence ISO 40.....	96
Pour granit avec cône 1/2"	96
Pour marbre - tête diamantée dépôt électrolytique	96
OUTILS POUR POLISSAGE DE LA SUPERFICIE - CNC	97
OUTILS POUR POLISSAGE DE LA SUPERFICIE - CNC	99

Diamètre de 150 mm pour des surfaces inclinées amplitude maximale 150 mm - granit et matériaux synthétiques	99
OUTILS À VIEILLIR.....	100
Brosse à vieillir pour la superficie diamètre 130.....	100
Brosse à vieillir pour la superficie diamètre 100.....	100
Brosse à vieillir le chant diamètre 150.....	101
OUTILS POUR POLISSAGE DES INTÉRIEURS DE CUVE SUR CNC	102
Pour agrégat Intermac.....	102
DIAMANT POUR POLISSOIR À CHANT	103
Process polissoire à champs	103
.....	104
.....	104
Comandulli.....	105
Montresor.....	106
Sassomeccanica	107
Breton	107
Park Industries	107
POLISSAGE RÉSIN POUR LE CHANT.....	108
Sequence grain conseillée pour chant droit	108
<i>Sequence grain conseillée pour arrondi</i>	109
<i>Sequence grain conseillée pour arête</i>	109
Polissage Resinee	110
DISQUE POUR COUPE À EAU	117
117	
PARAMETRES DE TRAVAIL.....	117
Granit - Marbre	117
Granit et synthétique.....	118
Marbre	119
Dekton + Matériaux céramique.....	120
DISQUE POUR COUPE À SEC	121
Granit.....	121
Marbre électrodéposé.....	122
Gres	122
DISQUE POUR CENTRE INTERMAC	123
Diamètre 180 pour coupe en forme.....	123
Diamètre 200 mm.....	123
Diamètre 250 mm.....	123

Diamètre 350 mm.....	123
Diamètre 500 mm.....	124
Diamètre 625 mm.....	124
Diamètre 230 pour coupe à 44°	124
Disco diametro 150 mm per taglio innesto rinforzo piani cucina RODDING	124
OUTILS POUR DEKTON®	125
FORÊTS	125
Forêt couronne continue attache 1/2" gas pour CNC	125
FRAISE.....	125
Fraise a secteur attache 1/2" pour CNC	125
Pastille pour coupe multi passe.....	126
Diamètre support 18mm.....	126
MEULE PERIPHERIQUE POUR DEKTON®	127
Séquence et type de meules diamant pour CNC.....	127
<i>Parametres de travail:</i>	127
Pour epaisseur 20 mm	128
Meule pour profil 45°	130
Meule de pré découpe	130
PLAN DU TRAVAIL.....	131
Forêt pour lavabo attache 1/2"	131
Meule attache 1/2" pour façonner l'intérieur de cuve.....	131
.....	131
<i>Parametres de travail:</i>	131
Pour epaisseur 20 mm	132
Pour epaisseur 30 mm	133
OUTILS POUR MATERIAUX SPECIAUX (*EX: CHINAGLASS®, LAMINAM®,WHITEGLASS®, KERLITE®, TECHLAM®, STONEGLASS®, MARMOGLASS®, ECC...)	134
* THE MANUFACTURERS' NAMES ARE USED FOR IDENTIFICATION PURPOSES ONLY. DIAMUT AND BIESSE GROUP HAVE NO TIES OF ANY NATURE WITH THESE COMPANIES.	134
FORÊTS	135
Forêt couronne continue attache 1/2" gas pour CNC	135
FRAISE.....	135
Fraise a secteur attache 1/2" pour CNC	135
Fraise boisseau attache 1/2" gas pour CNC	136
"Forêt pour lavabo attache 1/2"....."	137
MEULE PERIPHERIQUE POUR SINTERED MATERIALS.....	138
Typologie meules diamantées pour CNC	138

Epaisseur 3mm – 6 mm – 8 mm – 10 mm	138
<i>Parametres de travail:</i>	138
Pour epaisseur 3 mm.....	139
Pour epaisseur 6 mm.....	139
Pour epaisseur 8 mm.....	140
Pour epaisseur 10 mm	141
Typologie meules diamantées pour CNC	142
Epaisseur 12 mm – 15 mm – 20 mm	142
<i>Parametres de travail:</i>	142
Pour epaisseur 12 mm	143
Pour epaisseur 15 mm	144
Pour epaisseur 20 mm	145
Meule pour profil 45°	147
Meule d'ébauche corner breakers	147
PLAN DU TRAVAIL.....	148
Fraise pour cannelures attache 1/2" pour CNC.....	148
Meule attache 1/2" pour façonner l'intérieur de cuve	148
<i>Parametres de travail:</i>	148
Pour epaisseur 12mm	149
Pour epaisseur 20 mm	149
5 axes - V 0 Intermac	151
PIERRE DE POMPE POUR REVIVRE.....	152

kpl ligne



INFORMACIÓN TÉCNICA

Tabla de granos diamantada

FEPA	U.S MESH	DIAMUT	MESH SIZE
D427	40/50	B	50
D301	50/60	C	60
D252	60/80	E	80
D181	80/100	F	100
D151	100/120	G	120
D126	120/140	H	140
D107	140/170	I	170
D91	170/200	L	200
D76	200/230	M	230
D64	230/270	N	270
D54	270/325	Z	325
D46	325/400	P	400
D39	400/500	Q	500
D33	500/600	R	600

MICRON	U.S MESH	DIAMUT
40/60 μ	600	R
30/40 μ	800	S
22/36 μ	1000	T

Descripción de la meula diamantada

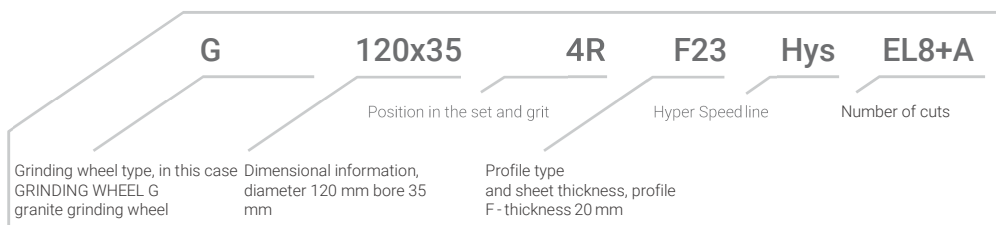

Información dimensional

A	Trou de perçage pour arrosage interne
D	Diamètre
H	Alesage
HC	Trou avec clef
J	Hub external diameter
R	Rayon
S	Angle pour le support de meule
T	Hauteur totale
T1	Reduced thickness of grinding wheel body
U	Profile opening
U1	Flat section of the profile (for trapezoidal grinding wheels)
V	Angle
W	Width of diamond ring
X	Epaisseur du diamant
Y	Depth of edge (for pencil edge wheels)
L	Longeur totale
L1	Longeur utile
L2	Longueur de la partie abrasive
Z	Nombre du segments
Y	Shaft diameter
@	Snail lock

Note: all dimensions given in this price list are in mm

Information matériel

ENG	Engineered stone
M	Marbre
HGR	Granit dure
SGR	Granit tendre
DK	Dekton
MT	Matériel synthétique

FORÊTS

Forêt segmenté

D	L	L1	MATÉRIEL	RPM HGR	RPM ENG	AVANCE mm/min	CODE	PRIX
18	104	50	HGR - SGR - M	4000-2500	6000-3000	30-40	D6782	€ 75,00
20	104	50	HGR - SGR - M	4000-2500	6000-3000	30-40	D6783	€ 75,00
22	104	50	HGR - SGR - M	2500-1800	3000-2500	30-40	D6827	€ 80,00
25	104	50	HGR - SGR - M	2500-1800	3000-2500	30-40	D6761	€ 85,00
30	104	50	HGR - SGR - M	2500-1800	3000-2500	30-40	D6743	€ 90,00
35	104	50	HGR - SGR - M	1800-1000	2500-1800	30-40	D6722	€ 95,00
40	104	50	HGR - SGR - M	1800-1000	2500-1800	30-40	D6767	€ 100,00
45	104	50	HGR - SGR - M	1000-800	1800-1500	30-40	D6786	€ 105,00
50	104	50	HGR - SGR - M	1000-800	1800-1500	30-40	D6684	€ 110,00
55	104	50	HGR - SGR - M	1000-800	1500-1200	30-40	D6787	€ 115,00
70	104	50	HGR - SGR - M	700-850	1200-1350	30-40	D6790	€ 135,00



Forêt couronne continue



D	L	L1	MATÉRIEL	RPM HGR	RPM ENG	AVANCE mm/min	CODE	PRIX
6	95	50	HGR - SGR - M	6000-4500	8000-5000	40-50	DOFGR000006	€ 46,00
8	95	50	HGR - SGR - M	4000-2500	6000-3000	40-50	DOFGR000008	€ 54,00
10	95	50	HGR - SGR - M	4000-2500	6000-3000	40-50	DOFGR000010	€ 59,00
12	95	50	HGR - SGR - M	4000-2500	6000-3000	40-50	DOFGR000012	€ 67,00
14	95	50	HGR - SGR - M	4000-2500	6000-3000	40-50	DOFGR000014	€ 73,00
15	95	50	HGR - SGR - M	4000-2500	6000-3000	40-50	DOFGR000015	€ 75,00
16	95	50	HGR - SGR - M	4000-2500	6000-3000	40-50	DOFGR000016	€ 78,00
18	95	50	HGR - SGR - M	4000-2500	6000-3000	40-50	DOFGR000018	€ 81,00
20	95	50	HGR - SGR - M	4000-2500	6000-3000	40-50	DOFGR000020	€ 83,00
22	95	50	HGR - SGR - M	2500-1800	3000-2500	40-50	DOFGR000022	€ 85,00
25	95	50	HGR - SGR - M	2500-1800	3000-2500	40-50	DOFGR000025	€ 86,00
28	95	50	HGR - SGR - M	2500-1800	3000-2500	40-50	DOFGR000028	€ 89,00
30	95	50	HGR - SGR - M	2500-1800	3000-2500	40-50	DOFGR000030	€ 90,00
32	95	50	HGR - SGR - M	1800-1000	2500-1800	40-50	DOFGR000032	€ 93,00
35	95	50	HGR - SGR - M	1800-1000	2500-1800	40-50	DOFGR000035	€ 95,00
38	95	50	HGR - SGR - M	1800-1000	2500-1800	40-50	DOFGR000038	€ 98,00
40	95	50	HGR - SGR - M	1800-1000	2500-1800	40-50	DOFGR000040	€ 106,00
42	95	50	HGR - SGR - M	1000-800	1800-1500	40-50	DOFGR000042	€ 110,00
45	95	50	HGR - SGR - M	1000-800	1800-1500	40-50	DOFGR000045	€ 117,00
50	95	50	HGR - SGR - M	1000-800	1800-1500	40-50	DOFGR000050	€ 123,00
55	95	50	HGR - SGR - M	1000-800	1500-1200	40-50	DOFGR000055	€ 127,00
60	95	50	HGR - SGR - M	1000-800	1500-1200	40-50	DOFGR000060	€ 129,00
65	95	50	HGR - SGR - M	850-650	1350-1050	40-50	DOFGR000065	€ 137,00
68	95	50	HGR - SGR - M	850-650	1350-1050	40-50	DOFGR000068	€ 143,00
70	95	50	HGR - SGR - M	800-600	1300-1000	40-50	DOFGR000070	€ 144,00
80	95	50	HGR - SGR - M	700-500	1200-900	40-50	DOFGR000080	€ 159,00
90	95	50	HGR - SGR - M	650-450	1150-850	40-50	DOFGR000090	€ 180,00
100	95	50	HGR - SGR - M	600-400	1100-800	40-50	DOFGR000100	€ 195,00

Forêt trou borgne granit L1-55

D	L	L1	MATÉRIEL	RPM	AVANCE mm/min	CODE	PRIX
5	105	55	HGR - SGR	6000-6200	20-30	D6665	€ 35,00
6	105	55	HGR - SGR	6000-6200	20-30	D6647	€ 33,00
7	105	55	HGR - SGR	6000-6200	20-30	D6724	€ 37,00
8	105	55	HGR - SGR	5800-6000	20-30	D6531	€ 42,00
10	105	55	HGR - SGR	5800-6000	20-30	D6533	€ 47,00
11	105	55	HGR - SGR	5800-6000	20-30	D6528	€ 53,00
12	105	55	HGR - SGR	5500-5800	20-30	D6532	€ 55,00
14	105	55	HGR - SGR	5500-2800	20-30	D6529	€ 59,00
15	105	55	HGR - SGR	5500-5800	20-30	D6875	€ 74,00
20	105	55	HGR - SGR	4500-5000	20-30	D6699	€ 128,00



Forêt trou borgne granit L1-40

D	L	L1	MATÉRIEL	RPM	AVANCE mm/min	CODE	PRIX
6	90	40	HGR - SGR	6000-6200	20-30	D6933	€ 33,00
8	90	40	HGR - SGR	5800-6000	20-30	D6930	€ 42,00
10	90	40	HGR - SGR	5800-6000	20-30	D6932	€ 47,00
12	90	40	HGR - SGR	5500-5800	20-30	D6931	€ 59,00
15	90	40	HGR - SGR	5500-5800	20-30	D6951	€ 74,00



FRAISE DE COUPE

Table d'application

TYPOLOGIE	ENG (agglomerate)	HGR (Granit dur)	SGR (Granit tendre)	MARBRE
Ligne black storm	✓	✓		
Or-haute durée	✓	✓		
Vert		✓		
Bleu			✓	
Electrodépot				✓

Ligne black storm



D	L	L1	Z	GRAIN	RPM	AVANCE ENG mm/min	AVANCE SGR mm/min	AVANCE HGR mm/min	CODE	PRIX
22	85	35	7	D427	7500-8000	400-700		350-400	DFR02265	€ 125,00
22	95	45	7	D427	7500-8000	400-700		350-400	DFR02266	€ 140,00
22	105	65	7	D427	7500-8000	400-700		350-400	DFR03052	€ 185,00

*Indiqué pour le synthétique/quarte et granit dure

Or-haute durée



D	L	L1	Z	GRAIN	RPM	AVANCE ENG mm/min	AVANCE SGR mm/min	AVANCE HGR mm/min	CODE	PRIX
20	89	40	5	D427	5000-5500	300-400		120-300	DFR01887	€ 120,00
20	93	45	5	D427	5000-5500	300-400		120-300	DFR01920	€ 127,00
22	85	35	5	D427	5000-5500	300-400		120-300	DFR02149	€ 148,00

*Indiqué pour le synthétique/quarte et granit dure

Vert

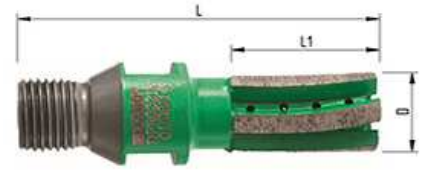

D	L	L1	Z	GRAIN	NOTE	RPM	AVANCE ENG mm/min	CODE	RIX
20	89	40	5	D427		5000-5500	100-200	DFR00982	€ 113,00
20	93	45	5	D427		5000-5500	100-200	DFR01100	€ 119,00
22	85	35	5	D427		5000-5500	100-200	DFR02215	€ 154,00
22	95	45	5	D427		5000-5500	100-200	DFR02264	€ 170,00
20	85	40	5+1	D427	Diamante in testa / Diamond in the head	5000-5500	100-200	DFR01310	€ 142,00

*indiqué pour le granit dure

Bleu

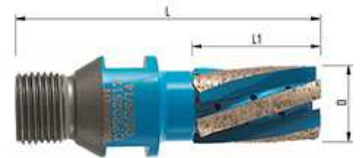

D	L	L1	Z	GRAIN	RPM	AVANCE ENG mm/min	AVANCE SGR mm/min	AVANCE HGR mm/min	CODE	RIX
22	85	35	5	D427	5000-6000	200-300	200-300	100-150	DFR02517	€ 127,00
22	85	45	5	D427	5000-6000	200-300	200-300	100-150	DFR02518	€ 148,00

*Indiqué pour le synthétique/quarte, granit dure et tendre

Electrodépot



D	L	L1	GRAIN	RPM	AVANCE mm/min	CODE	RIX
6	84	23	D427	10000-12000	150-200	DFFR00646	€ 130,00
8	84	23	D427	8000-10000	150-200	DFFR00647	€ 130,00
10	84	23	D427	5000-6000	200-300	DFFR00639	€ 139,00
12	84	23	D427	5000-6000	200-300	DFFR00652	€ 147,00
16	84	25	D602	4500-5500	250-500	DFFR00697	€ 170,00
16	85	35	D602	7000-8000	250-500	DFFR00621	€ 133,00
16	95	45	D602	7000-8000	250-500	DFFR00622	€ 192,00
20	84	50	D602	4000-5000	250-500	DFFR00640	€ 259,00
20	110	60	D602	4000-5000	250-500	DFFR00620	€ 265,00
22	130	80	D602	4000-5000	250-500	DFFR00708	€ 351,00
25	130	80	D602	4000-5000	250-500	DFFR00641	€ 387,00
25	160	110	D602	4000-5000	250-500	DFFR00011	€ 540,00

Da diametro 6 mm a 12 mm adatte per intarsi

*Indiqué pour marbre

Fraise pour granit diamètre 24mm

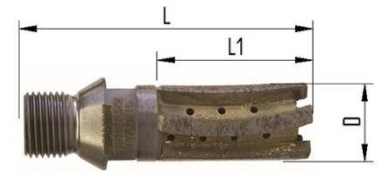

D	L	L1	GRAIN	RPM	AVANCE mm/min	CODE	PRIX
24	66	25	D427	4500-5000	200-350	DFR06747	€ 102,00
24	94	35	D427	4500-5000	200-350	DFR00669	€ 113,00
24	85	45	D427	4500-5000	200-350	DFR07022	€ 119,00
24	103	60	D427	4500-5000	200-350	DFR00265	€ 141,00
24	112	70	D301	4500-5000	200-350	DFR00198	€ 223,00

Fraise vacuum brazed

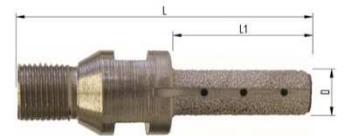

D	L	L1	GRAIN	RPM	AVANCE mm/min	CODE	PRIX
10	85	35	D602	8000-10000	400-600	DFFR00790	€ 85,00
14	95	45	D602	6000-8000	600-1000	DFFR90745	€ 100,00
16	105	55	D602	6000-8000	600-1000	DFFR90227	€ 112,00
18	95	45	D602	6000-8000	600-1000	DFFR90642	€ 120,00
18	130	80	D602	6000-8000	600-1000	DFFR90228	€ 137,00
16	95	45	D602	6000-8000	600-1000	DFFR90046	€ 108,00
25	100	50	D427	6000-8000	600-1000	DFFR90359	€ 129,00
25	100	50	D181	6000-8000	600-1000	DFFR90362	€ 129,00
25	100	50	D91	6000-8000	600-1000	DFFR90363	€ 129,00
50	100	50	D427	5000-7000	600-1000	DFFR90364	€ 205,00
50	100	50	D181	5000-7000	600-1000	DFFR90365	€ 205,00
50	100	50	D91	5000-7000	600-1000	DFFR90366	€ 205,00

Pastilles pour la coupe en passe

D	L1	H	MATÉRIEL	RPM	AVANCE mm/min	ENLEVEMENT mm	CODE	PRIX
20	20	M12	ENG - HGR - SGR	6000-8000	1000-1500	2-3	DPT01D	€ 95,00
25	18	M14	HGR - SGR - M	6000-8000	1000-1500	2-3	DPT03	€ 145,00
25	18	M14	ABR	6000-8000	1000-1500	2-3	DPT08	€ 208,00
20	10	M12	M	6000-7000	1000-1500	2-5	DPT05	€ 108,00
20	20	M12	M	6000-7000	1000-1500	2-5	DPT06	€ 198,00



Support avec fixation 1/2" GAS pour les pastilles de coupe passées

Diamètre support 18mm



D	L	L1	H	ALESAGE	CODE	PRIX
18	40	40	1/2 GAS	M12	D12109	€ 80,00
18	66	66	1/2 GAS	M12	D9631	€ 80,00
18	120	120	1/2 GAS	M12	D9632	€ 80,00
18	150	150	1/2 GAS	M12	D9769	€ 80,00
18	65	65	1/2 GAS	M14	D9562	€ 80,00
18	120	120	1/2 GAS	M14	D9432	€ 80,00

Diamètre support 23mm



D	L	L1	H	ALESAGE	CODE	PRIX
23	100	100	1/2 GAS	M14	D10009	€ 110,00
23	130	130	1/2 GAS	M14	D9772	€ 110,00
23	253	253	1/2 GAS	M14	D9837	€ 110,00

Supports pour cône ISO 40 pour les pastilles de coupe passées

Diamètre support 23 mm

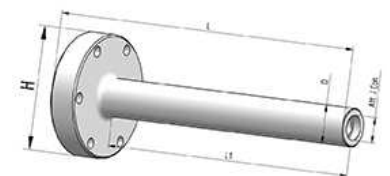

D	L	L1	H	ALESAGE	CODE	PRIX
23	150	150	50+6F	M14	D10612	€ 180,00
23	170	170	50+6F	M14	D10365	€ 180,00

FORÊTS GAUCHE (SX)

Forêt couronne continue



D	L	L1	MATÉRIEL	RPM HGR	RPM ENG	AVANCE mm/min	CODE	PRIX
10	95	50	HGR - SGR - M	4000-2500	6000-3000	40-50	DOFGR000010SX	€ 62,00
12	95	50	HGR - SGR - M	4000-2500	6000-3000	40-50	DOFGR000012SX	€ 70,00
14	95	50	HGR - SGR - M	4000-2500	6000-3000	40-50	DOFGR000014SX	€ 77,00
15	95	50	HGR - SGR - M	4000-2500	6000-3000	40-50	DOFGR000015SX	€ 79,00
16	95	50	HGR - SGR - M	4000-2500	6000-3000	40-50	DOFGR000016SX	€ 82,00
18	95	50	HGR - SGR - M	4000-2500	6000-3000	40-50	DOFGR000018SX	€ 85,00
20	95	50	HGR - SGR - M	4000-2500	6000-3000	40-50	DOFGR000020SX	€ 90,00
22	95	50	HGR - SGR - M	2500-1800	3000-2500	40-50	DOFGR000022SX	€ 91,00
25	95	50	HGR - SGR - M	2500-1800	3000-2500	40-50	DOFGR000025SX	€ 92,00
28	95	50	HGR - SGR - M	2500-1800	3000-2500	40-50	DOFGR000028SX	€ 92,00
30	95	50	HGR - SGR - M	2500-1800	3000-2500	40-50	DOFGR000030SX	€ 93,00
32	95	50	HGR - SGR - M	1800-1000	2500-1800	40-50	DOFGR000032SX	€ 94,00
35	95	50	HGR - SGR - M	1800-1000	2500-1800	40-50	DOFGR000035SX	€ 99,00
38	95	50	HGR - SGR - M	1800-1000	2500-1800	40-50	DOFGR000038SX	€ 105,00
40	95	50	HGR - SGR - M	1800-1000	2500-1800	40-50	DOFGR000040SX	€ 122,00
42	95	50	HGR - SGR - M	1000-800	1800-1500	40-50	DOFGR000042SX	€ 128,00
45	95	50	HGR - SGR - M	1000-800	1800-1500	40-50	DOFGR000045SX	€ 138,00
50	95	50	HGR - SGR - M	1000-800	1800-1500	40-50	DOFGR000050SX	€ 155,00

PASTILLE POUR LA COUPE EN PASSE A GAUCHE

Pastilles pour la coupe en passe

D	L1	H	MATÉRIEL	RPM	AVANCE mm/min	ENLEVEMENT mm	CODE	PRIX
20	20	M12 SX	ENG - HGR - SGR	6000-8000	1000-1500	2-3	DPT127	€ 95,00
25	15	M14 SX	HGR - SGR - M	6000-8000	1000-1500	2-3	DPT135	€ 152,00
30	15	M14 SX	HGR - SGR - M	4500-6500	1000-1500	2-3	DPT134	€ 152,00
16	11	M10 SX	DK	6500-8500	400-600	2	DPT136K	€ 152,00



Support avec fixation 1/2" GAS pour les pastilles de coupe passées gauche

Diamètre support 18mm

D	L	L1	H	ALESAGE	CODE	PRIX
18	40	40	1/2 GAS DX	M12	D12829	€ 90,00
18	66	66	1/2 GAS	M12	D10463	€ 90,00
18	66	66	1/2 GAS	M12	D12830	€ 90,00



Diamètre support 23 mm

D	L	L1	H	ALESAGE	CODE	PRIX
23	100	100	1/2 GAS	M14	D12865	€ 90,00



FRAISE DE COUPE AVEC ATTAQUE A GAUCHE

Ligne black storm



D	L	L1	Z	GRAIN	RPM	AVANCE ENG mm/min	AVANCE SGR mm/min	AVANCE HGR mm/min	CODE	PRIX
22	95	45	7	D427	7500-8000	400-700		350-400	DFR02266SX	€ 160,00

Indiqué pour le synthétique/quarte et granit dure

Or-haute durée

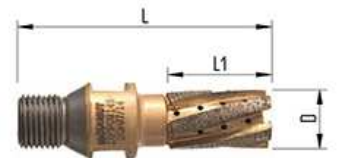

D	L	L1	Z	GRAIN	RPM	AVANCE ENG mm/min	AVANCE SGR mm/min	AVANCE HGR mm/min	CODE	PRIX
22	93	45	5	D427	5000-5500	300-400		120-300	DFR01920SX	€ 146,00

Indiqué pour le synthétique/quarte et granit dure

Vert

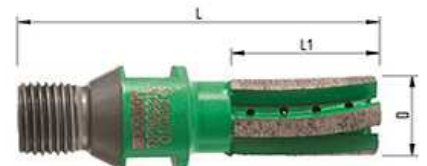

D	L	L1	Z	GRAIN	NOTE	RPM	AVANCE ENG mm/min	CODE	PRIX
20	89	40	5	D427		5000-5500	100-200	DFR00982SX	€ 130,00
20	93	45	5	D427		5000-5500	100-200	DFR01100SX	€ 138,00
20	85	40	5+1	D427	Diamante in testa / Diamond in the head	5000-5500	100-200	DFR01310SX	€ 163,00

indiqué pour le granit dure

Bleu

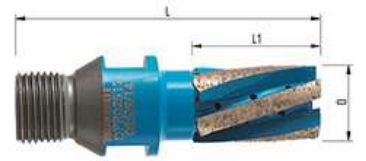

D	L	L1	Z	GRAIN	RPM	AVANCE ENG mm/min	AVANCE SGR mm/min	AVANCE HGR mm/min	CODE	PRIX
22	85	45	5	D427	5000-6000	200-300	200-300	100-150	DFR02518SX	€ 160,00

Indiqué pour le synthétique/quarte, granit dure et tendre

Electrodépot

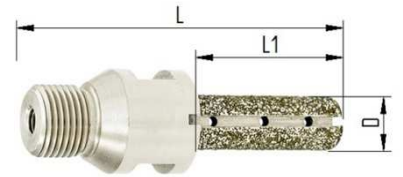

D	L	L1	GRAIN	RPM	AVANCE mm/min	CODE	PRIX
16	85	35	D602	7000-8000	600-1000	DFFR00621SX	€ 135,00
16	95	45	D602	7000-8000	600-1000	DFFR00622SX	€ 155,00
20	84	50	D602	6000-7000	1000-1500	DFFR00640SX	€ 160,00
20	110	60	D602	6000-7000	1000-1500	DFFR00620SX	€ 225,00

Indiqué pour marbre

MEULE DE CALIBRAGE

Aves secteur standard

POS	D	H	T	TYPE D'ARTICLE	CODE	PRIX
1	80	35	33,5	Gros secteur	DGS82469	€ 455,00
2	80	35	33,5	Medium segmented	DGS82261	€ 455,00
1	80	35	45	Gros secteur	DGS82580	€ 476,00
2	80	35	45	Medium segmented	DGS82581	€ 476,00



CODE	RPM	AVANCE mm/min	ENLEVEMENT mm
DGS82469	6000	1500-2000	1-2
DGS82261	6000	2500-3000	0,2-0,4
DGS82580	6000	1500-2000	1-2
DGS82581	6000	2500-3000	0,2-0,4

Avec secteur a flèche

POS	D	H	T	TYPE D'ARTICLE	CODE	PRIX
1	80	35	35	Gros secteur	DGS83271	€ 480,00
2	80	35	35	Medium segmented	DGS83272	€ 480,00
1	80	35	45	Gros secteur	DGS83273	€ 500,00
2	80	35	45	Medium segmented	DGS83274	€ 500,00

CODE	RPM	AVANCE mm/min	ENLEVEMENT mm
DGS83271	6000	800-1200	2
DGS83272	6000	1800-2500	0,4
DGS83273	6000	800-1200	2
DGS83274	6000	1800-2500	0,4



MEULE D'ÉBAUCHE CORNER BREAKERS

Meule casse aretes a secteur profil X



Keen Product line per granito e materiali sintetici

POS	D	ID	H	T	RPM	AVANCE mm/min	ENLEVEMENT mm	CODE	PRIX
1	120	86	35	56	5500	800-1200	800-1200	DGS77010	€ 545,00
1	120	60	35	83	5500	800-1200	800-1200	DGS75838	€ 715,00

Meules casse aretes a secteur profil Y



Keen Product line per granito e materiali sintetici

POS	D	ID	H	T	RPM	AVANCE mm/min	ENLEVEMENT mm	CODE	PRIX
1	120	55	35	42	5500	800-1200	800-1200	DGS75232	€ 318,00
1	120	53	35	45	5500	800-1200	800-1200	DGS72079	€ 454,00

WHEELS FOR EDGE PROFILING – KPL LINE

Meules diamantée et polissage pour granit et matériaux synthétiques



POS.1	POS.2	POS.3	POS.4	POS.5	POS.6	POS.7
1B DIAMANT SECTEUR	2H DIAMANT CONTINUE	3N DIAMANT CONTINUE	4S DIAMANT CONTINUE	BLEU FLASH POLISSAGE 60 mm	BLANCHE FLASH POLISSAGE 60 mm	GRISE FLASH POLISSAGE 60 mm

La gamme de produits KPL: innovant, polyvalent et efficace.

La nouvelle gamme de roues périphériques produites à Diamut a été développée pour répondre aux besoins du marché en pleine croissance. C'est l'évolution technologique parfaite de la gamme Standard Diamut. Convient supervisé les machines à commande numérique.

Meules de polissage en résine

- ✓ Seulement 2 étapes suffisent pour un excellent résultat;
- ✓ Uniquement pour Granite;
- ✓ Pour toutes les machines CNC pouvant gérer automatiquement l'usure des meules;
- ✓ Pour toute forme spéciale, toujours correspondre (sinon après quelques mètres, ils le feront) ;
- ✓ Moins cher ;
- ✓ Tous les profils disponibles sur demande



Utilisation recommandée pour les meules métalliques

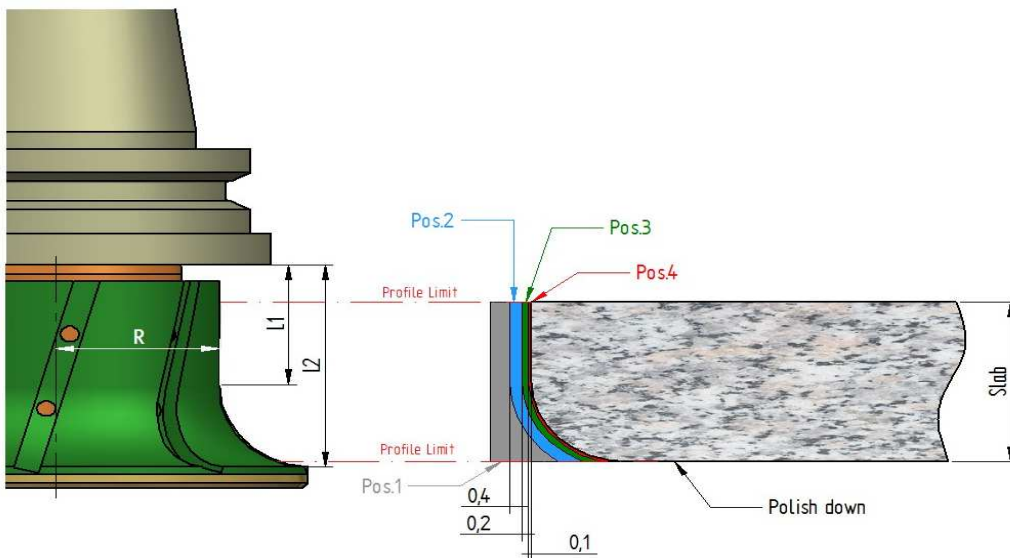
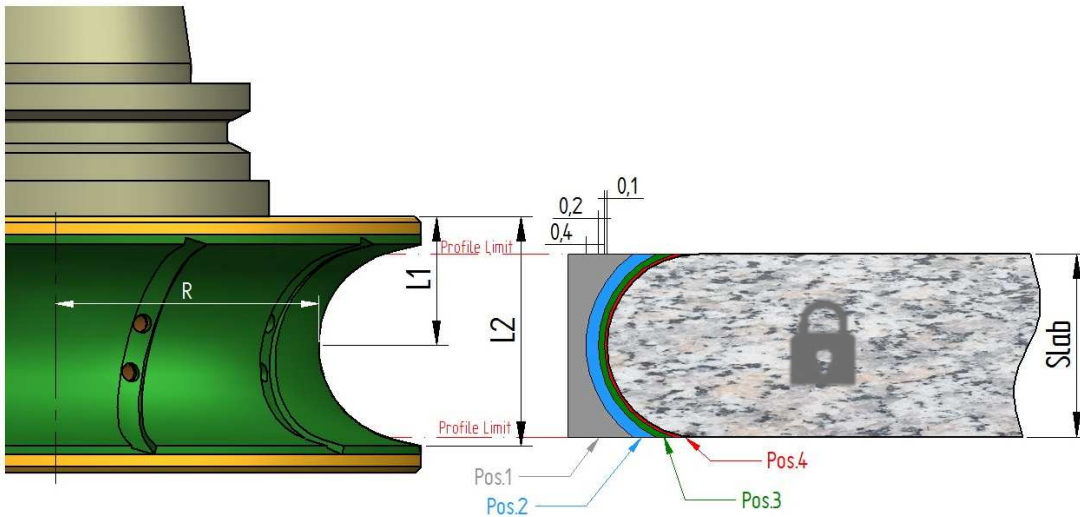

Profil ferme

Utilisation recommandée pour les meules Flash Polissage

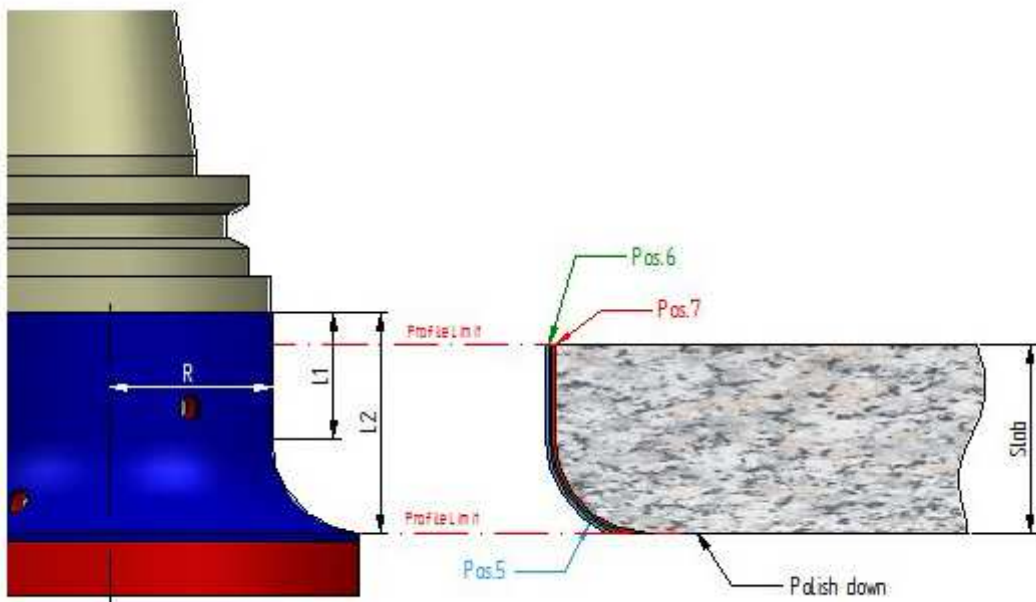
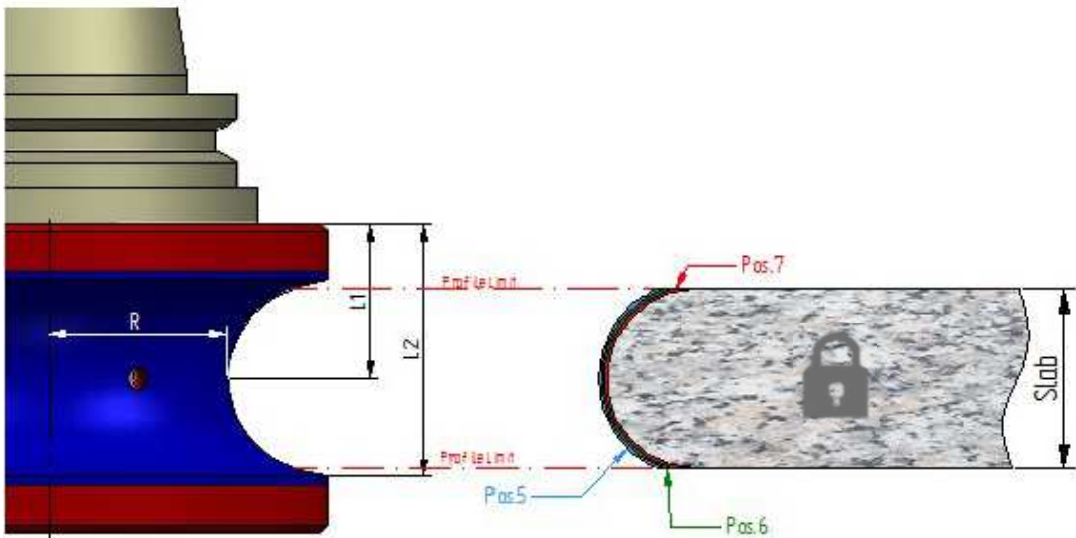



















Profil ferme







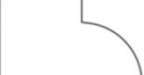



Meules diamètre 120 mm

Profils disponibles sur le catalogue



Profil ferme

PROFIL	SPÉCIFICATION DU PROFIL	PROFIL	SPÉCIFICATION DU PROFIL
	A A23 R10 A33 R6 A33 R10 A33 R15 A33 R20 A43 R20		AFR AFR33 R15 R3
	AK2 AK2 33 R30		AK31 AK31 32
	B B23 R20 B33 R30		BFR BFR33 R30
	E E33 B8 E33 B11,5 E33 B16		EFR EFR33 B11,5 R4
	F F23 R12 F33 R17,4		FB FB43
	FBR FBR33 R10 R3		FV FV33 FV43 FV63
	FZ FZ36 R10 FZ43 R10		FZR01 FZR01 33
	G G23 G33 G43		GV GV43
	H H23 H36		L L23 L33

PROFIL	SPÉCIFICATION DU PROFIL	PROFIL	SPÉCIFICATION DU PROFIL
	O O33		Q Q33
	SK07 SK0733		T T23 R3 T23 R6 T32 R6 T33 R3 T33 R8 T42 R6 T42 R8 T43 R3 T63 R6
	TK43 TK43 33		TK57 TK57 33
	TP TP33		V V23 V63 V33 V43
	X X20 18x25 X30 26x33 X40 36x43		Z Z22 Z33 Z43

Parametres de travail –KPL:

POS	D	TYPE D'ARTICLE	RPM	AVANCE (mm/min)	ENLEVEMENT (mm)
1	120	Gros secteur	5500	800-1200	2
2	120	Couronne continue ebauche	5500	1800-3000	0,4
3	120	Couronne continue medium	5500	1800-3000	0,2
4	120	Couronne continue fine	5500	800-1500	0,1-0,05
5	120	Flash bleu 60 mm	2700	1000-1500	0,05
6	120	Flash blanche 60 mm	2700	1000-1500	0,05
7	120	Flash grise 60 mm	2700	1000-1500	0,05

A23 R10

POS	D	ID	H	TYPE D'ARTICLE	CODE	PRIX
1	120	100	35	Gros secteur	DGS74070	€ 432,00
2	120	100	35	Couronne continue ebauche	DGS70882	€ 428,00
3	120	100	35	Couronne continue medium	DGS70883	€ 428,00
4	120	100	35	Couronne continue fine	DGS70884	€ 428,00
5	80	60	35	Flash Bleu	DLG30280	€ 173,00 *
6	80	60	35	Flash Blanche	DLG30281	€ 173,00 *
7	80	60	35	Flash Grise	DLG30282	€ 173,00 *

PRIX TOTAL DU SET:2.235,00 €

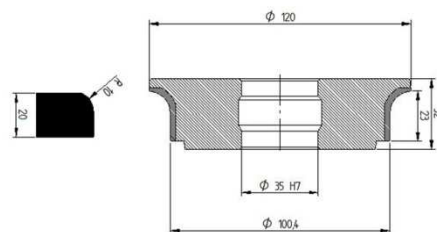

A33 R6

POS	D	ID	H	TYPE D'ARTICLE	CODE	PRIX
1	120	104	35	Gros secteur	DGS72388	€ 482,00
2	120	104	35	Couronne continue ebauche	DGS72389	€ 545,00
3	120	104	35	Couronne continue medium	DGS72390	€ 545,00
4	120	104	35	Couronne continue fine	DGS72391	€ 545,00
5	76	60	35	Flash Bleu	DLG30682	€ 189,00 *
6	76	60	35	Flash Blanche	DLG30683	€ 189,00 *
7	76	60	35	Flash Grise	DLG30684	€ 189,00 *

PRIX TOTAL DU SET:2.684,00 €

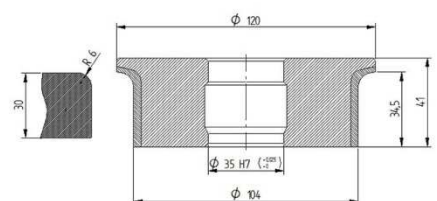

A33 R10

POS	D	ID	H	TYPE D'ARTICLE	CODE	PRIX
1	120	101	35	Gros secteur	DGS70544	€ 526,00
2	120	101	35	Couronne continue ebauche	DGS71930	€ 518,00
3	120	101	35	Couronne continue medium	DGS71931	€ 518,00
4	120	101	35	Couronne continue fine	DGS71932	€ 518,00
5	79	60	35	Flash Bleu	DLG30655	€ 189,00 *
6	79	60	35	Flash Blanche	DLG30656	€ 189,00 *
7	79	60	35	Flash Grise	DLG30657	€ 189,00 *

PRIX TOTAL DU SET:2.647,00 €

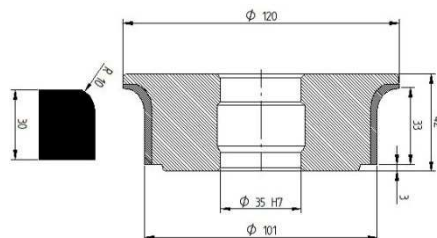

A33 R15

POS	D	ID	H	TYPE D'ARTICLE	CODE	PRIX
1	120	92	35	Gros secteur	DGS71516	€ 442,00
2	120	92	35	Couronne continue ebauche	DGS71517	€ 496,00
3	120	92	35	Couronne continue medium	DGS71518	€ 496,00
4	120	92	35	Couronne continue fine	DGS71519	€ 496,00
5	80	52	35	Flash Bleu	DLG30346	€ 194,00 *
6	80	52	35	Flash Blanche	DLG30347	€ 194,00 *
7	80	52	35	Flash Grise	DLG30348	€ 194,00 *

PRIX TOTAL DU SET:2.512,00 €

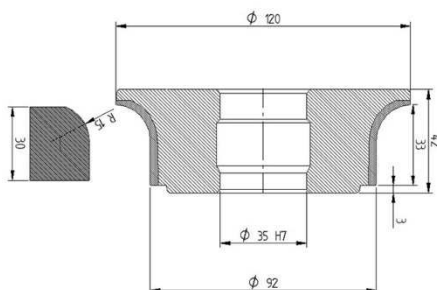

A33 R20

POS	D	ID	H	TYPE D'ARTICLE	CODE	PRIX
1	120	81	35	Gros secteur	DGS74468	€ 513,00
2	120	81	35	Couronne continue ebauche	DGS74469	€ 498,00
3	120	81	35	Couronne continue medium	DGS74470	€ 498,00
4	120	81	35	Couronne continue fine	DGS74471	€ 498,00
5	99	60	35	Flash Bleu	DLG30424	€ 218,00 *
6	99	60	35	Flash Blanche	DLG30425	€ 218,00 *
7	99	60	35	Flash Grise	DLG30426	€ 218,00 *

PRIX TOTAL DU SET:2.661,00 €

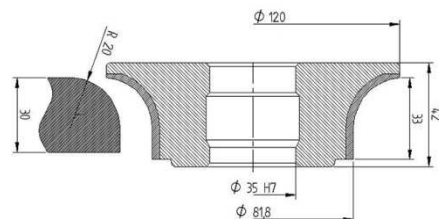

A43 R20

POS	D	ID	H	TYPE D'ARTICLE	CODE	PRIX
1	120	82	35	Gros secteur	DGS70010	€ 533,00
2	120	82	35	Couronne continue ebauche	DGS70778	€ 621,00
3	120	82	35	Couronne continue medium	DGS70779	€ 621,00
4	120	82	35	Couronne continue fine	DGS70885	€ 621,00
5	80	60	35	Flash Bleu	DLG30037	€ 218,00 *
6	80	60	35	Flash Blanche	DLG30038	€ 218,00 *
7	80	60	35	Flash Grise	DLG30039	€ 218,00 *

PRIX TOTAL DU SET:3.050,00 €

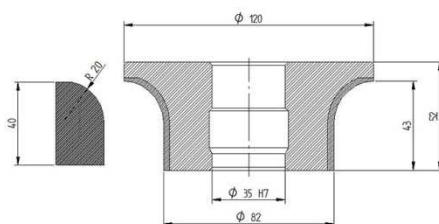

AFR33 R15 R3

POS	D	ID	H	TYPE D'ARTICLE	CODE	PRIX
1	120	92	35	Gros secteur	DGS71516	€ 442,00
2	120	89,6	35	Couronne continue ebauche	DGS78789	€ 575,00
3	120	89,6	35	Couronne continue medium	DGS78790	€ 575,00
4	120	89,6	35	Couronne continue fine	DGS78791	€ 575,00
5	80	59,4	35	Flash Bleu	DLG30689	€ 189,00 *
6	80	59,4	35	Flash Blanche	DLG30690	€ 189,00 *
7	80	59,4	35	Flash Grise	DLG30691	€ 189,00 *

PRIX TOTAL DU SET:2.734,00 €

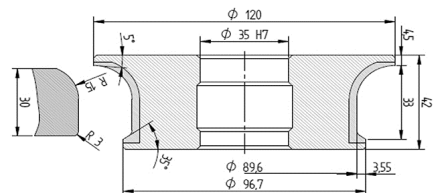

AK2 33 R30

POS	D	ID	H	TYPE D'ARTICLE	CODE	PRIX
1	120	110	35	Gros secteur	DGS83348	€ 561,00
2	120	110	35	Couronne continue ebauche	DGS83349	€ 613,00
3	120	110	35	Couronne continue medium	DGS83350	€ 613,00
4	120	110	35	Couronne continue fine	DGS83351	€ 613,00
5	70	60	35	Flash Bleu	DLG30658	€ 189,00 *
6	70	60	35	Flash Blanche	DLG30659	€ 189,00 *
7	70	60	35	Flash Grise	DLG30660	€ 189,00 *

PRIX TOTAL DU SET:2.967,00 €

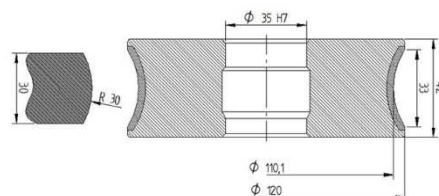

AK31 32

POS	D	ID	H	TYPE D'ARTICLE	CODE	PRIX
1	120	75,9	35	Gros secteur	DGS76558	€ 545,00
2	120	75,9	35	Couronne continue ebauche	DGS72172	€ 587,00
3	120	75,9	35	Couronne continue medium	DGS72173	€ 587,00
4	120	75,9	35	Couronne continue fine	DGS72174	€ 587,00
5	104	60	35	Flash Bleu	DLG30996	€ 229,00 *
6	104	60	35	Flash Blanche	DLG30997	€ 229,00 *
7	104	60	35	Flash Grise	DLG30998	€ 229,00 *

PRIX TOTAL DU SET:2.993,00 €

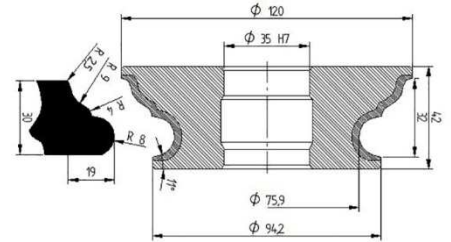

B23 R20

POS	D	ID	H	TYPE D'ARTICLE	CODE	PRIX
1	120	75	35	Gros secteur	DGS75408	€ 442,00
2	120	75	35	Couronne continue ebauche	DGS70835	€ 473,00
3	120	75	35	Couronne continue medium	DGS70836	€ 473,00
4	120	75	35	Couronne continue fine	DGS70837	€ 473,00
5	105	60	35	Flash Bleu	DLG30298	€ 228,00 *
6	105	60	35	Flash Blanche	DLG30299	€ 228,00 *
7	105	60	35	Flash Grise	DLG30300	€ 228,00 *

PRIX TOTAL DU SET:2.545,00 €

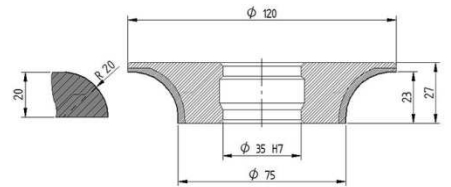

B33 R30

POS	D	ID	H	TYPE D'ARTICLE	CODE	PRIX
1	120	57	35	Gros secteur	DGS73703	€ 466,00
2	120	57	35	Couronne continue ebauche	DGS72730	€ 530,00
3	120	57	35	Couronne continue medium	DGS72731	€ 530,00
4	120	57	35	Couronne continue fine	DGS72732	€ 530,00
5	120	60	35	Flash Bleu	DLG30112	€ 228,00 *
6	120	60	35	Flash Blanche	DLG30113	€ 228,00 *
7	120	60	35	Flash Grise	DLG30114	€ 228,00 *

PRIX TOTAL DU SET:2.740,00 €

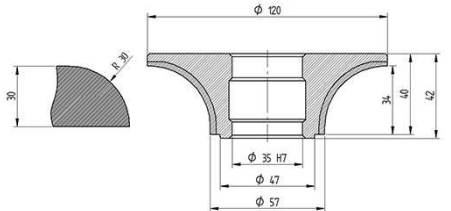

BFR33 R30

POS	D	ID	H	TYPE D'ARTICLE	CODE	PRIX
1	120	57	35	Gros secteur	DGS73703	€ 466,00
2	120	59	35	Couronne continue ebauche	DGS79808	€ 572,00
3	120	59	35	Couronne continue medium	DGS79809	€ 572,00
4	120	59	35	Couronne continue fine	DGS79810	€ 572,00
5	120	60	35	Flash Bleu	DLG30358	€ 275,00 *
6	120	60	35	Flash Blanche	DLG30359	€ 275,00 *
7	120	60	35	Flash Grise	DLG30360	€ 275,00 *

PRIX TOTAL DU SET:3.007,00 €

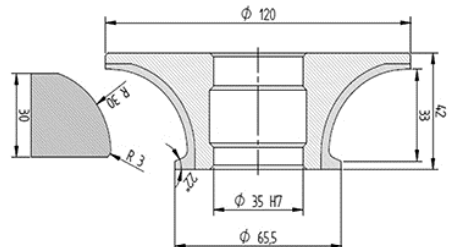

E33 B8

POS	D	ID	H	TYPE D'ARTICLE	CODE	PRIX
1	120	104	35	Gros secteur	DGS77716	€ 476,00
2	120	104	35	Couronne continue ebauche	DGS77713	€ 552,00
3	120	104	35	Couronne continue medium	DGS77714	€ 552,00
4	120	104	35	Couronne continue fine	DGS77715	€ 552,00
5	76	60	35	Flash Bleu	DLG30241	€ 228,00 *
6	76	60	35	Flash Blanche	DLG30242	€ 228,00 *
7	76	60	35	Flash Grise	DLG30243	€ 228,00 *

PRIX TOTAL DU SET:2.816,00 €

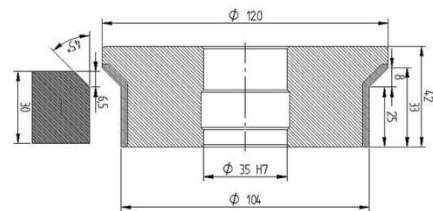

E33 B11,5

POS	D	ID	H	TYPE D'ARTICLE	CODE	PRIX
1	120	97	35	Gros secteur	DGS77069	€ 511,00
2	120	97	35	Couronne continue ebauche	DGS73037	€ 575,00
3	120	97	35	Couronne continue medium	DGS73038	€ 575,00
4	120	97	35	Couronne continue fine	DGS73039	€ 575,00
5	83	60	35	Flash Bleu	DLG30121	€ 196,00 *
6	83	60	35	Flash Blanche	DLG30122	€ 196,00 *
7	83	60	35	Flash Grise	DLG30123	€ 196,00 *

PRIX TOTAL DU SET:2.824,00 €

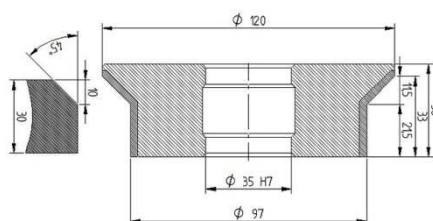

E33 B16

POS	D	ID	H	TYPE D'ARTICLE	CODE	PRIX
1	120	88	35	Gros secteur	DGS74487	€ 627,00
2	120	88	35	Couronne continue ebauche	DGS74488	€ 533,00
3	120	88	35	Couronne continue medium	DGS74489	€ 533,00
4	120	88	35	Couronne continue fine	DGS74490	€ 533,00
5	92	60	35	Flash Bleu	DLG30016	€ 189,00 *
6	92	60	35	Flash Blanche	DLG30017	€ 189,00 *
7	92	60	35	Flash Grise	DLG30018	€ 189,00 *

PRIX TOTAL DU SET:2.793,00 €

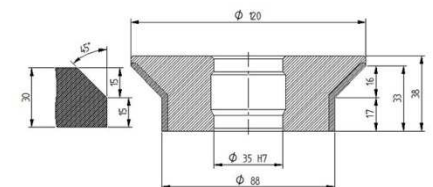

EFR33 B11,5 R4

POS	D	ID	H	TYPE D'ARTICLE	CODE	PRIX
1	120	97	35	Gros secteur	DGS77069	€ 511,00
2	120	100	35	Couronne continue ebauche	DGS75392	€ 621,00
3	120	100	35	Couronne continue medium	DGS75393	€ 621,00
4	120	100	35	Couronne continue fine	DGS75394	€ 621,00
5	83	60	35	Flash Bleu	DLG30631	€ 250,00 *
6	83	60	35	Flash Blanche	DLG30632	€ 250,00 *
7	83	60	35	Flash Grise	DLG30633	€ 250,00 *

PRIX TOTAL DU SET:3.124,00 €

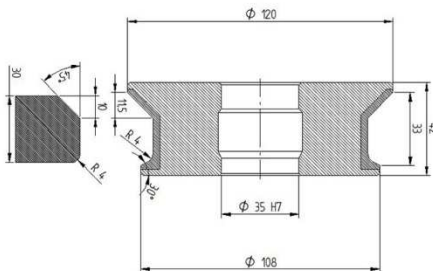

F23 R12

POS	D	ID	H	TYPE D'ARTICLE	CODE	PRIX
1	120	73,5	35	Gros secteur	DGS72898	€ 466,00
2	120	73,5	35	Couronne continue ebauche	DGS70767	€ 485,00
3	120	73,5	35	Couronne continue medium	DGS70768	€ 485,00
4	120	73,5	35	Couronne continue fine	DGS70777	€ 485,00
5	107	60	35	Flash Bleu	DLG30499	€ 195,00 *
6	107	60	35	Flash Blanche	DLG30500	€ 195,00 *
7	107	60	35	Flash Grise	DLG30501	€ 195,00 *

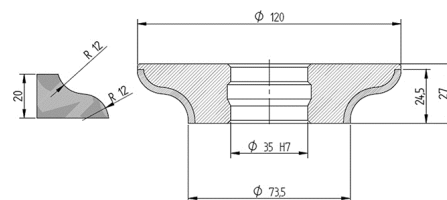

PRIX TOTAL DU SET: 2.506,00 €

Conseil l'utilisation de meule cassage d'arêtes type Y

F33 R17,4

POS	D	ID	H	TYPE D'ARTICLE	CODE	PRIX
1	120	58	35	Gros secteur	DGS70415	€ 533,00
2	120	58	35	Couronne continue ebauche	DGS70898	€ 552,00
3	120	58	35	Couronne continue medium	DGS70899	€ 552,00
4	120	58	35	Couronne continue fine	DGS70900	€ 552,00
5	122	60	35	Flash Bleu	DLG30019	€ 228,00 *
6	122	60	35	Flash Blanche	DLG30020	€ 228,00 *
7	122	60	35	Flash Grise	DLG30021	€ 228,00 *

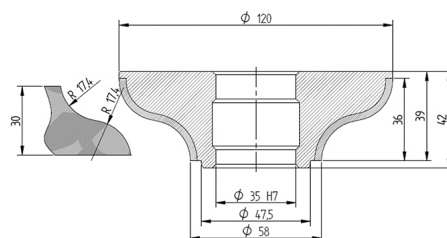

PRIX TOTAL DU SET: 2.873,00 €

Conseil l'utilisation de meule cassage d'arêtes type Y

F43

POS	D	ID	H	TYPE D'ARTICLE	CODE	PRIX
1	140	58	35	Gros secteur	DGS74570	€ 650,00
2	140	58	35	Couronne continue ebauche	DGS74307	€ 741,00
3	140	58	35	Couronne continue medium	DGS74308	€ 741,00
4	140	58	35	Couronne continue fine	DGS74309	€ 741,00
5	120	58	35	Flash Bleu	DLG31613	€ 256,00 *
6	120	58	35	Flash Blanche	DLG31614	€ 256,00 *
7	120	58	35	Flash Grise	DLG31615	€ 256,00 *

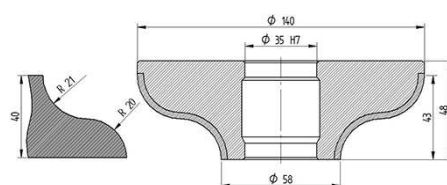

PRIX TOTAL DU SET: 3.641,00 €

FB43

POS	D	ID	H	TYPE D'ARTICLE	CODE	PRIX
1	120	78	35	Gros secteur	DGS73931	€ 703,00
2	120	78	35	Couronne continue ebauche	DGS73932	€ 632,00
3	120	78	35	Couronne continue medium	DGS73933	€ 632,00
4	120	78	35	Couronne continue fine	DGS73934	€ 632,00
5	102	60	35	Flash Bleu	DLG31066	€ 302,00 *
6	102	60	35	Flash Blanche	DLG31067	€ 302,00 *
7	102	60	35	Flash Grise	DLG31068	€ 302,00 *

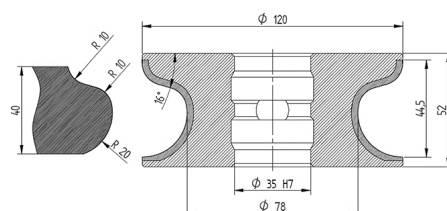

PRIX TOTAL DU SET: 3.505,00 €

Conseil l'utilisation de meule cassage d'arêtes type Y

FBR33 R10 R3

POS	D	ID	H	TYPE D'ARTICLE	CODE	PRIX
1	120	72	35	Gros secteur	DGS80335	€ 502,00
2	120	72	35	Couronne continue ebauche	DGS80336	€ 662,00
3	120	72	35	Couronne continue medium	DGS80337	€ 662,00
4	120	72	35	Couronne continue fine	DGS80338	€ 662,00
5	108	60	35	Flash Bleu	DLG30634	€ 248,00 *
6	108	60	35	Flash Blanche	DLG30635	€ 248,00 *
7	108	60	35	Flash Grise	DLG30636	€ 248,00 *

PRIX TOTAL DU SET:3.232,00 €

Conseil l'utilisation de meule cassage d'arêtes type Y

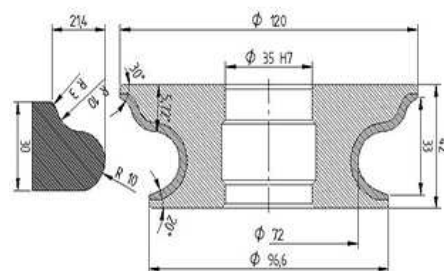

FV33

POS	D	ID	H	TYPE D'ARTICLE	CODE	PRIX
1	120	76,5	35	Gros secteur	DGS75283	€ 499,00
2	120	76,5	35	Couronne continue ebauche	DGS76517	€ 609,00
3	120	76,5	35	Couronne continue medium	DGS76518	€ 609,00
4	120	76,5	35	Couronne continue fine	DGS76519	€ 609,00
5	104	60	35	Flash Bleu	DLG30172	€ 228,00 *
6	104	60	35	Flash Blanche	DLG30173	€ 228,00 *
7	104	60	35	Flash Grise	DLG30174	€ 228,00 *

PRIX TOTAL DU SET:3.010,00 €

Conseil l'utilisation de meule cassage d'arêtes type Y

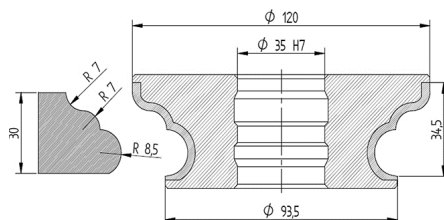

FV43

POS	D	ID	H	TYPE D'ARTICLE	CODE	PRIX
1	120	62	35	Gros secteur	DGS73514	€ 669,00
2	120	62	35	Couronne continue ebauche	DGS73515	€ 678,00
3	120	62	35	Couronne continue medium	DGS73516	€ 678,00
4	120	62	35	Couronne continue fine	DGS73517	€ 678,00
5	118	60	35	Flash Bleu	DLG30725	€ 212,00 *
6	118	60	35	Flash Blanche	DLG30726	€ 212,00 *
7	118	60	35	Flash Grise	DLG30727	€ 212,00 *

PRIX TOTAL DU SET:3.339,00 €

Conseil l'utilisation de meule cassage d'arêtes type Y

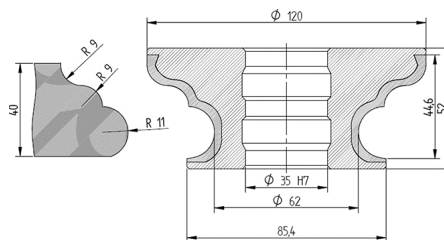

FV63

POS	D	ID	H	TYPE D'ARTICLE	CODE	PRIX
1	140	66	35	Gros secteur	DGS82619	€ 1.254,00
2	140	66	35	Couronne continue ebauche	DGS82620	€ 1.356,00
3	140	66	35	Couronne continue medium	DGS82621	€ 1.356,00
4	140	66	35	Couronne continue fine	DGS82622	€ 1.356,00
5	140	60	35	Flash Bleu	DLG31733	€ 365,00 *
6	140	60	35	Flash Blanche	DLG31734	€ 365,00 *
7	140	60	35	Flash Grise	DLG31735	€ 365,00 *

PRIX TOTAL DU SET:6.417,00 €

Conseil l'utilisation de meule cassage d'arêtes type Y

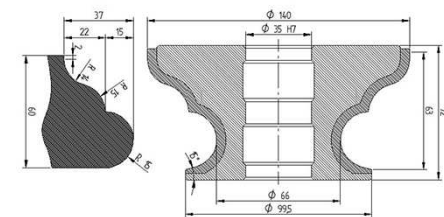

FZ36 R10

POS	D	ID	H	TYPE D'ARTICLE	CODE	PRIX
1	120	80	35	Gros secteur	DGS78193	€ 545,00
2	120	80	35	Couronne continue ebauche	DGS74910	€ 564,00
3	120	80	35	Couronne continue medium	DGS74702	€ 564,00
4	120	80	35	Couronne continue fine	DGS74703	€ 564,00
5	100	60	35	Flash Bleu	DLG30247	€ 212,00 *
6	100	60	35	Flash Blanche	DLG30248	€ 212,00 *
7	100	60	35	Flash Grise	DLG30249	€ 212,00 *

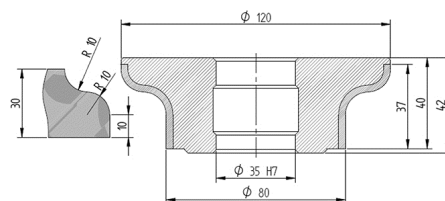

PRIX TOTAL DU SET:2.873,00 €

Conseil l'utilisation de meule cassage d'arêtes type Y

FZ43 R10

POS	D	ID	H	TYPE D'ARTICLE	CODE	PRIX
1	120	80	35	Gros secteur	DGS78344	€ 602,00
2	120	80	35	Couronne continue ebauche	DGS75764	€ 621,00
3	120	80	35	Couronne continue medium	DGS75765	€ 621,00
4	120	80	35	Couronne continue fine	DGS75766	€ 621,00
5	100	60	35	Flash Bleu	DLG30277	€ 288,00 *
6	100	60	35	Flash Blanche	DLG30278	€ 288,00 *
7	100	60	35	Flash Grise	DLG30279	€ 288,00 *

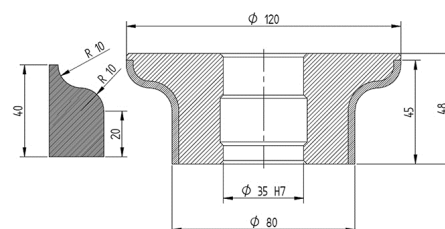

PRIX TOTAL DU SET:3.329,00 €

Conseil l'utilisation de meule cassage d'arêtes type Y

FZR01 33

POS	D	ID	H	TYPE D'ARTICLE	CODE	PRIX
1	120	80	35	Gros secteur	DGS78193	€ 545,00
2	120	74	35	Couronne continue ebauche	DGS82343	€ 612,00
3	120	74	35	Couronne continue medium	DGS82344	€ 612,00
4	120	74	35	Couronne continue fine	DGS82345	€ 612,00
5	106	60	35	Flash Bleu	DLG30673	€ 256,00 *
6	106	60	35	Flash Blanche	DLG30674	€ 256,00 *
7	106	60	35	Flash Grise	DLG30675	€ 256,00 *

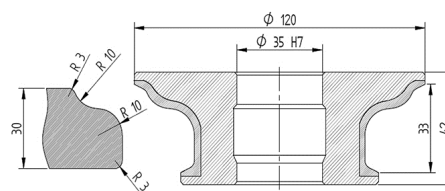

PRIX TOTAL DU SET:3.149,00 €

Conseil l'utilisation de meule cassage d'arêtes type Y

G23

POS	D	ID	H	TYPE D'ARTICLE	CODE	PRIX
1	120	81	35	Gros secteur	DGS76277	€ 432,00
2	120	81	35	Couronne continue ebauche	DGS70844	€ 461,00
3	120	81	35	Couronne continue medium	DGS70845	€ 461,00
4	120	81	35	Couronne continue fine	DGS70846	€ 461,00
5	99	60	35	Flash Bleu	DLG30352	€ 228,00 *
6	99	60	35	Flash Blanche	DLG30353	€ 228,00 *
7	99	60	35	Flash Grise	DLG30354	€ 228,00 *

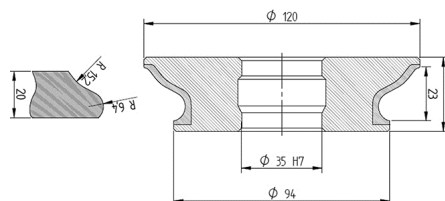

PRIX TOTAL DU SET:2.499,00 €

Conseil l'utilisation de meule cassage d'arêtes type Y

G33

POS	D	ID	H	TYPE D'ARTICLE	CODE	PRIX
1	120	68	35	Gros secteur	DGS74690	€ 499,00
2	120	68	35	Couronne continue ebauche	DGS71242	€ 518,00
3	120	68	35	Couronne continue medium	DGS71243	€ 518,00
4	120	68	35	Couronne continue fine	DGS71244	€ 518,00
5	112	60	35	Flash Bleu	DLG30000	€ 228,00 *
6	112	60	35	Flash Blanche	DLG30001	€ 228,00 *
7	112	60	35	Flash Grise	DLG30002	€ 228,00 *

PRIX TOTAL DU SET: 2.737,00 €

Conseil l'utilisation de meule cassage d'arêtes type Y

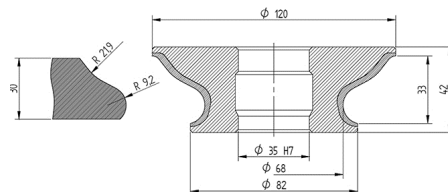

G43

POS	D	ID	H	TYPE D'ARTICLE	CODE	PRIX
1	120	52	35	Gros secteur	DGS74719	€ 624,00
2	120	52	35	Couronne continue ebauche	DGS71589	€ 587,00
3	120	52	35	Couronne continue medium	DGS71590	€ 587,00
4	120	52	35	Couronne continue fine	DGS71591	€ 587,00
5	120	52	35	Flash Bleu	DLG30355	€ 258,00 *
6	120	52	35	Flash Blanche	DLG30356	€ 258,00 *
7	120	52	35	Flash Grise	DLG30357	€ 258,00 *

PRIX TOTAL DU SET: 3.159,00 €

Conseil l'utilisation de meule cassage d'arêtes type Y

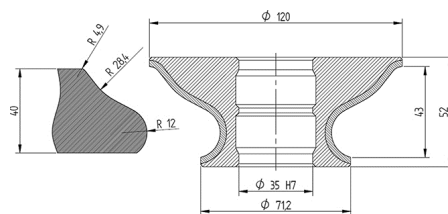

GV43

POS	D	ID	H	TYPE D'ARTICLE	CODE	PRIX
1	120	80	35	Gros secteur	DGS73293	€ 624,00
2	120	80	35	Couronne continue ebauche	DGS73294	€ 632,00
3	120	80	35	Couronne continue medium	DGS71431	€ 632,00
4	120	80	35	Couronne continue fine	DGS71432	€ 632,00
5	100	60	35	Flash Bleu	DLG30160	€ 258,00 *
6	100	60	35	Flash Blanche	DLG30161	€ 258,00 *
7	100	60	35	Flash Grise	DLG30162	€ 258,00 *

PRIX TOTAL DU SET: 3.294,00 €

Conseil l'utilisation de meule cassage d'arêtes type Y

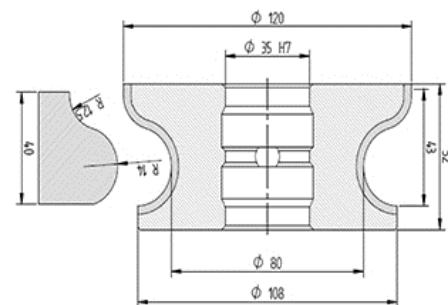

H23

POS	D	ID	H	TYPE D'ARTICLE	CODE	PRIX
1	120	80	35	Gros secteur	DGS70090	€ 488,00
2	120	80	35	Couronne continue ebauche	DGS71344	€ 496,00
3	120	80	35	Couronne continue medium	DGS71345	€ 496,00
4	120	80	35	Couronne continue fine	DGS71346	€ 496,00
5	100	60	35	Flash Bleu	DLG31018	€ 228,00 *
6	100	60	35	Flash Blanche	DLG31019	€ 228,00 *
7	100	60	35	Flash Grise	DLG31020	€ 228,00 *

PRIX TOTAL DU SET: 2.660,00 €

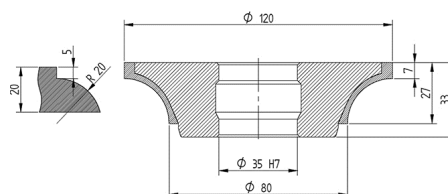

H36

POS	D	ID	H	TYPE D'ARTICLE	CODE	PRIX
1	120	74	35	Gros secteur	DGS72618	€ 533,00
2	120	74	35	Couronne continue ebauche	DGS71790	€ 552,00
3	120	74	35	Couronne continue medium	DGS71791	€ 552,00
4	120	74	35	Couronne continue fine	DGS71792	€ 552,00
5	106	60	35	Flash Bleu	DLG30244	€ 228,00 *
6	106	60	35	Flash Blanche	DLG30245	€ 228,00 *
7	106	60	35	Flash Grise	DLG30246	€ 228,00 *

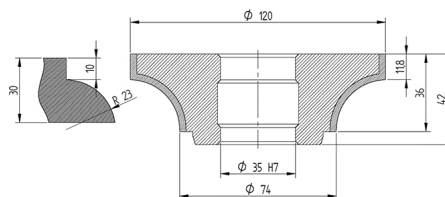

PRIX TOTAL DU SET:2.873,00 €

L23

POS	D	ID	H	TYPE D'ARTICLE	CODE	PRIX
1	120	100	35	Gros secteur	DGS73021	€ 403,00
2	120	100	35	Couronne continue ebauche	DGS73022	€ 485,00
3	120	100	35	Couronne continue medium	DGS73023	€ 485,00
4	120	100	35	Couronne continue fine	DGS73024	€ 485,00
5	80	60	35	Flash Bleu	DLG30797	€ 228,00 *
6	80	60	35	Flash Blanche	DLG30798	€ 228,00 *
7	80	60	35	Flash Grise	DLG30799	€ 228,00 *

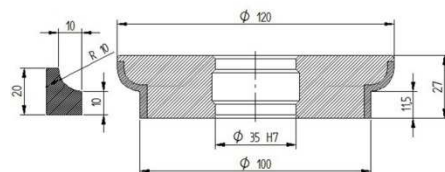

PRIX TOTAL DU SET:2.542,00 €

L33

POS	D	ID	H	TYPE D'ARTICLE	CODE	PRIX
1	120	72	35	Gros secteur	DGS72867	€ 522,00
2	120	72	35	Couronne continue ebauche	DGS72868	€ 610,00
3	120	72	35	Couronne continue medium	DGS72869	€ 610,00
4	120	72	35	Couronne continue fine	DGS72870	€ 610,00
5	108	60	35	Flash Bleu	DLG30740	€ 228,00 *
6	108	60	38	Flash Blanche	DLG30741	€ 228,00 *
7	108	60	35	Flash Grise	DLG30742	€ 228,00 *

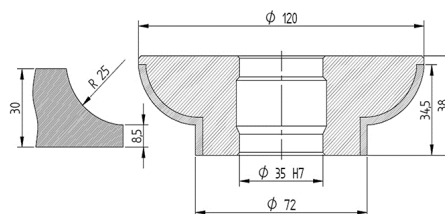

PRIX TOTAL DU SET:3.036,00 €

O33

POS	D	ID	H	TYPE D'ARTICLE	CODE	PRIX
1	120	70	35	Gros secteur	DGS70120	€ 567,00
2	120	70	35	Couronne continue ebauche	DGS71234	€ 564,00
3	120	70	35	Couronne continue medium	DGS71235	€ 564,00
4	120	70	35	Couronne continue fine	DGS71236	€ 564,00
5	110	60	35	Flash Bleu	DLG31039	€ 243,00 *
6	110	60	35	Flash Blanche	DLG31040	€ 243,00 *
7	110	60	35	Flash Grise	DLG31041	€ 243,00 *

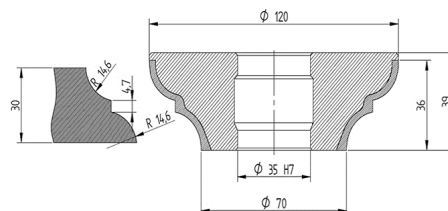

PRIX TOTAL DU SET:2.988,00 €

Conseil l'utilisation de meule cassage d'arêtes type Y

Q33

POS	D	ID	H	TYPE D'ARTICLE	CODE	PRIX
1	120	66	35	Gros secteur	DGS75496	€ 567,00
2	120	66	35	Couronne continue ebauche	DGS70871	€ 564,00
3	120	66	35	Couronne continue medium	DGS70872	€ 564,00
4	120	66	35	Couronne continue fine	DGS70873	€ 564,00
5	114	60	35	Flash Bleu	DLG30211	€ 228,00 *
6	114	60	35	Flash Blanche	DLG30212	€ 228,00 *
7	114	60	35	Flash Grise	DLG30213	€ 228,00 *

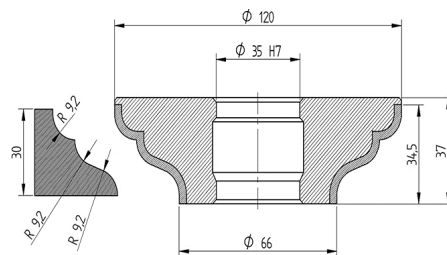

PRIX TOTAL DU SET: 2.943,00 €

Conseil l'utilisation de meule cassage d'arêtes type Y

SK0733

POS	D	ID	H	TYPE D'ARTICLE	CODE	PRIX
1	120	69	35	Gros secteur	DGS72829	€ 511,00
2	120	69	35	Couronne continue ebauche	DGS72024	€ 609,00
3	120	69	35	Couronne continue medium	DGS72025	€ 609,00
4	120	69	35	Couronne continue fine	DGS72026	€ 609,00
5	111	60	35	Flash Bleu	DLG30514	€ 288,00 *
6	111	60	35	Flash Blanche	DLG30515	€ 288,00 *
7	111	60	35	Flash Grise	DLG30516	€ 288,00 *

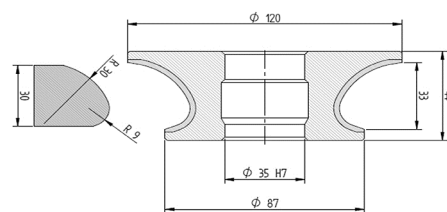

PRIX TOTAL DU SET: 3.202,00 €

T23 R3

POS	D	ID	H	TYPE D'ARTICLE	CODE	PRIX
1	120	120	35	Gros secteur	DGS72707	€ 454,00
2	120	113	35	Couronne continue ebauche	DGS70859	€ 485,00
3	120	113	35	Couronne continue medium	DGS70860	€ 485,00
4	120	113	35	Couronne continue fine	DGS70861	€ 485,00
5	67	60	35	Flash Bleu	DLG30006	€ 172,00 *
6	67	60	35	Flash Blanche	DLG30007	€ 172,00 *
7	67	60	35	Flash Grise	DLG30008	€ 172,00 *

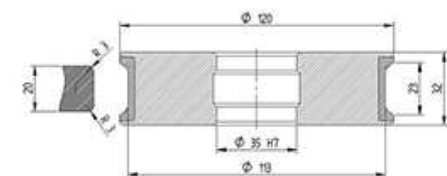

PRIX TOTAL DU SET: 2.425,00 €

T23 R6

POS	D	ID	H	TYPE D'ARTICLE	CODE	PRIX
1	120	108	35	Gros secteur	DGS81052	€ 430,00
2	120	108	35	Couronne continue ebauche	DGS81053	€ 470,00
3	120	108	35	Couronne continue medium	DGS81054	€ 470,00
4	120	108	35	Couronne continue fine	DGS81055	€ 470,00
5	72	60	35	Flash Bleu	DLG31142	€ 173,00 *
6	72	60	35	Flash Blanche	DLG31143	€ 173,00 *
7	72	60	35	Flash Grise	DLG31144	€ 173,00 *

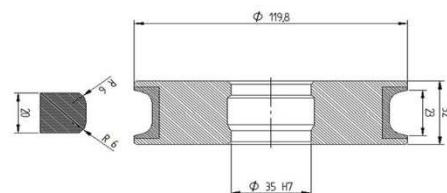

PRIX TOTAL DU SET: 2.359,00 €

T33 R3

POS	D	ID	H	TYPE D'ARTICLE	CODE	PRIX
1	120	120	35	Gros secteur	DGS70255	€ 522,00
2	120	113	35	Couronne continue ebauche	DGS71199	€ 552,00
3	120	113	35	Couronne continue medium	DGS71200	€ 552,00
4	120	113	35	Couronne continue fine	DGS71201	€ 552,00
5	67	60	35	Flash Bleu	DLG30133	€ 189,00 *
6	67	60	35	Flash Blanche	DLG30134	€ 189,00 *
7	67	60	35	Flash Grise	DLG30135	€ 189,00 *

PRIX TOTAL DU SET:2.745,00 €

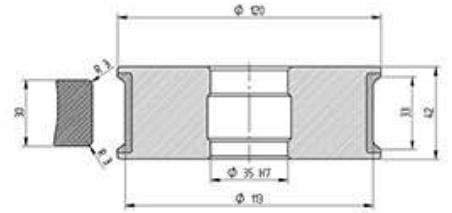

T32 R6

POS	D	ID	H	TYPE D'ARTICLE	CODE	PRIX
1	120	104	35	Gros secteur	DGS74548	€ 533,00
2	120	104	35	Couronne continue ebauche	DGS74549	€ 609,00
3	120	104	35	Couronne continue medium	DGS74550	€ 609,00
4	120	104	35	Couronne continue fine	DGS74551	€ 609,00
5	76	60	35	Flash Bleu	DLG30646	€ 200,00 *
6	76	60	35	Flash Blanche	DLG30647	€ 200,00 *
7	76	60	35	Flash Grise	DLG30648	€ 200,00 *

PRIX TOTAL DU SET:2.960,00 €

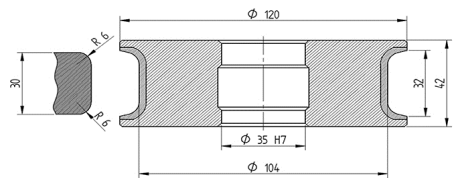

T33 R8

POS	D	ID	H	TYPE D'ARTICLE	CODE	PRIX
1	120	103	35	Gros secteur	DGS70577	€ 413,00
2	120	103	35	Couronne continue ebauche	DGS74529	€ 587,00
3	120	103	35	Couronne continue medium	DGS74530	€ 587,00
4	120	103	35	Couronne continue fine	DGS74531	€ 587,00
5	77	60	35	Flash Bleu	DLG30250	€ 228,00 *
6	77	60	35	Flash Blanche	DLG30251	€ 228,00 *
7	77	60	35	Flash Grise	DLG30252	€ 228,00 *

PRIX TOTAL DU SET:2.858,00 €

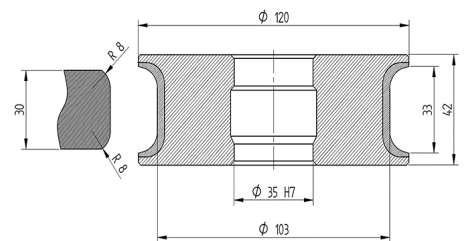

T42 R6

POS	D	ID	H	TYPE D'ARTICLE	CODE	PRIX
1	120	106	35	Gros secteur	DGS76294	€ 589,00
2	120	106	35	Couronne continue ebauche	DGS76263	€ 557,00
3	120	106	35	Couronne continue medium	DGS76264	€ 557,00
4	120	106	35	Couronne continue fine	DGS76265	€ 557,00
5	74	60	35	Flash Bleu	DLG30652	€ 256,00 *
6	74	60	35	Flash Blanche	DLG30653	€ 256,00 *
7	74	60	35	Flash Grise	DLG30654	€ 256,00 *

PRIX TOTAL DU SET:3.028,00 €

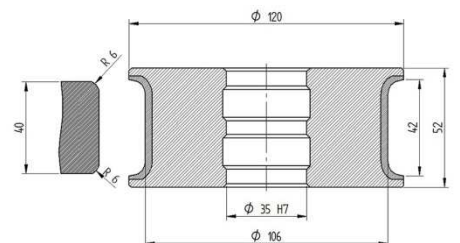

T42 R8

POS	D	ID	H	TYPE D'ARTICLE	CODE	PRIX
1	120	97	35	Gros secteur	DGS75619	€ 544,00
2	120	97	35	Couronne continue ebauche	DGS75620	€ 639,00
3	120	97	35	Couronne continue ebauche	DGS75621	€ 639,00
4	120	97	35	Couronne continue fine	DGS75622	€ 639,00
5	83	60	35	Flash Bleu	DLG30770	€ 237,00 *
6	83	60	35	Flash Blanche	DLG30771	€ 237,00 *
7	83	60	35	Flash Grise	DLG30772	€ 237,00 *

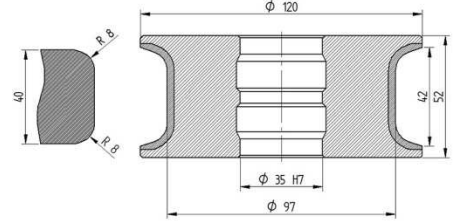

PRIX TOTAL DU SET: 3.172,00 €

T43 R3

POS	D	ID	H	TYPE D'ARTICLE	CODE	PRIX
1	120	120	35	Gros secteur	DGS70496	€ 624,00
2	120	113	35	Couronne continue ebauche	DGS71543	€ 621,00
3	120	113	35	Couronne continue medium	DGS71544	€ 621,00
4	120	112	35	Couronne continue fine	DGS71545	€ 621,00
5	67	60	35	Flash Bleu	DLG30313	€ 288,00 *
6	67	60	35	Flash Blanche	DLG30314	€ 288,00 *
7	67	60	35	Flash Grise	DLG30315	€ 288,00 *

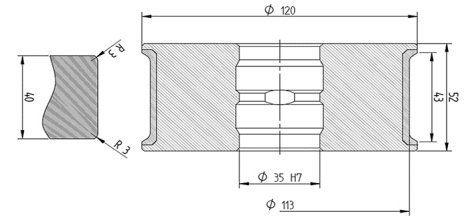

PRIX TOTAL DU SET: 3.351,00 €

T63 R6

POS	D	ID	H	TYPE D'ARTICLE	CODE	PRIX
1	120	103	35	Gros secteur	DGS76266	€ 765,00
2	120	103	35	Gros secteur	DGS76236	€ 765,00
3	120	103	35	Medium segmented	DGS76237	€ 765,00
4	120	103	35	Fine segmented	DGS76238	€ 765,00
5	77	60	35	Flash Bleu	DLG30773	€ 368,00 *
6	77	60	35	Flash Blanche	DLG30774	€ 368,00 *
7	77	60	35	Flash Grise	DLG30775	€ 368,00 *

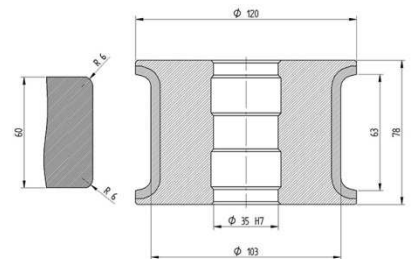

PRIX TOTAL DU SET: 4.164,00 €

TK43 33

POS	D	ID	H	TYPE D'ARTICLE	CODE	PRIX
1	120	70	35	Gros secteur	DGS82202	€ 544,00
2	120	70	35	Couronne continue ebauche	DGS82452	€ 573,00
3	120	70	35	Couronne continue medium	DGS82453	€ 573,00
4	120	70	35	Couronne continue fine	DGS82454	€ 573,00
5	110	60	35	Flash Bleu	DLG30667	€ 256,00 *
6	110	60	35	Flash Blanche	DLG30668	€ 256,00 *
7	110	60	35	Flash Grise	DLG30669	€ 256,00 *

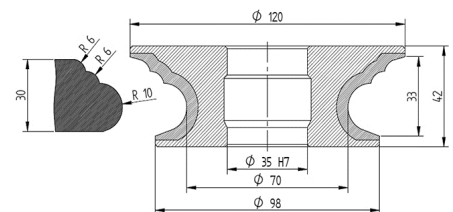

PRIX TOTAL DU SET: 3.031,00 €

Conseil l'utilisation de meule cassage d'arêtes type Y

TK57 33

POS	D	ID	H	TYPE D'ARTICLE	CODE	PRIX
1	120	56	35	Gros secteur	DGS78993	€ 567,00
2	120	56	35	Couronne continue ebauche	DGS78994	€ 598,00
3	120	56	35	Couronne continue medium	DGS78995	€ 598,00
4	120	56	35	Couronne continue fine	DGS78996	€ 598,00
5	120	56	35	Flash Bleu	DLG31693	€ 228,00 *
6	120	56	35	Flash Blanche	DLG31694	€ 228,00 *
7	120	56	35	Flash Grise	DLG31695	€ 228,00 *

PRIX TOTAL DU SET:3.045,00 €

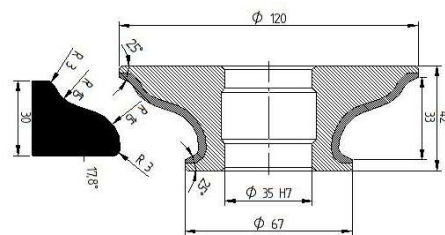

TP33

POS	D	ID	H	TYPE D'ARTICLE	CODE	PRIX
1	120	60	35	Gros secteur	DGS74729	€ 545,00
2	120	60	35	Couronne continue ebauche	DGS71138	€ 564,00
3	120	60	35	Couronne continue medium	DGS71139	€ 564,00
4	120	60	35	Couronne continue fine	DGS71140	€ 564,00
5	120	60	35	Flash Bleu	DLG30028	€ 228,00 *
6	120	60	35	Flash Blanche	DLG30029	€ 228,00 *
7	120	60	35	Flash Grise	DLG30030	€ 228,00 *

PRIX TOTAL DU SET:2.921,00 €

Conseil l'utilisation de meule cassage d'arêtes type Y

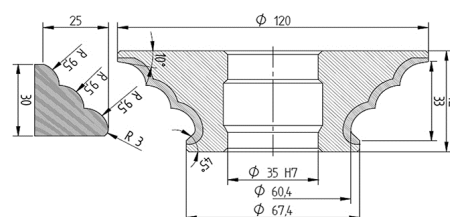

V22

POS	D	ID	H	TYPE D'ARTICLE	CODE	PRIX
1	120	96	35	Gros secteur	DGS70190	€ 386,00
2	120	96	35	Couronne continue ebauche	DGS70853	€ 542,00
3	120	96	35	Couronne continue medium	DGS70854	€ 542,00
4	120	96	35	Couronne continue fine	DGS70855	€ 542,00
5	84	60	35	Flash Bleu	DLG30340	€ 196,00 *
6	84	60	35	Flash Blanche	DLG30341	€ 196,00 *
7	84	60	35	Flash Grise	DLG30342	€ 196,00 *

PRIX TOTAL DU SET:2.600,00 €

Conseil l'utilisation de meule cassage d'arêtes type X

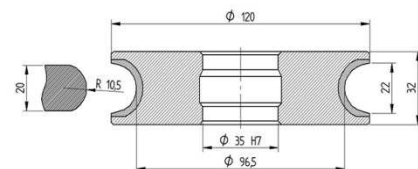

V33

POS	D	ID	H	TYPE D'ARTICLE	CODE	PRIX
1	120	86	35	Gros secteur	DGS74661	€ 476,00
2	120	86	35	Couronne continue ebauche	DGS72151	€ 632,00
3	120	86	35	Couronne continue medium	DGS72152	€ 632,00
4	120	86	35	Couronne continue fine	DGS72153	€ 632,00
5	94	60	35	Flash Bleu	DLG30031	€ 189,00 *
6	94	60	35	Flash Blanche	DLG30032	€ 189,00 *
7	94	60	35	Flash Grise	DLG30033	€ 189,00 *

PRIX TOTAL DU SET:2.939,00 €

Conseil l'utilisation de meule cassage d'arêtes type X

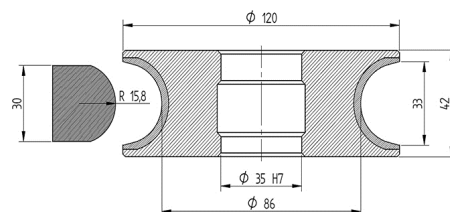

V43

POS	D	ID	H	TYPE D'ARTICLE	CODE	PRIX
1	120	75	35	Gros secteur	DGS75407	€ 511,00
2	120	75	35	Couronne continue ebauche	DGS72319	€ 712,00
3	120	75	35	Couronne continue medium	DGS72320	€ 712,00
4	120	75	35	Couronne continue fine	DGS72321	€ 712,00
5	105	60	35	Flash Bleu	DLG30040	€ 226,00 *
6	105	60	35	Flash Blanche	DLG30041	€ 226,00 *
7	105	60	35	Flash Grise	DLG30042	€ 226,00 *

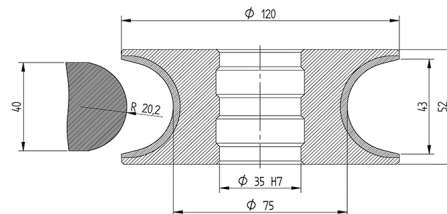

PRIX TOTAL DU SET:3.325,00 €

Conseil l'utilisation de meule cassage d'arêtes type X

V63 R30

POS	D	ID	H	TYPE D'ARTICLE	CODE	PRIX
1	120	60	35	Gros secteur	DGS78815	€ 681,00
2	120	60	35	Couronne continue ebauche	DGS83386	€ 910,00
3	120	60	35	Couronne continue medium	DGS83387	€ 910,00
4	120	60	35	Couronne continue fine	DGS83388	€ 910,00
5	120	60	35	Flash Bleu	DLG30746	€ 365,00 *
6	120	60	35	Flash Blanche	DLG30747	€ 365,00 *
7	120	60	35	Flash Grise	DLG30748	€ 365,00 *

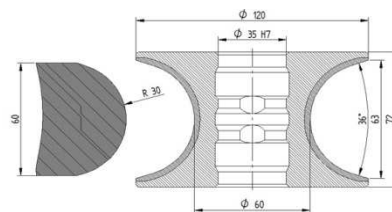

PRIX TOTAL DU SET:4.506,00 €

Conseil l'utilisation de meule cassage d'arêtes type X

X20 18x25

POS	D	ID	H	TYPE D'ARTICLE	CODE	PRIX
1	120	120	35	Gros secteur	DGS72707	€ 454,00
2	120	113	35	Couronne continue ebauche	DGS76972	€ 485,00
3	120	113	35	Couronne continue medium	DGS76973	€ 485,00
4	120	113	35	Couronne continue fine	DGS76974	€ 485,00
5	67	60	35	Flash Bleu	DLG30142	€ 192,00 *
6	67	60	35	Flash Blanche	DLG30143	€ 192,00 *
7	67	60	35	Flash Grise	DLG30144	€ 192,00 *

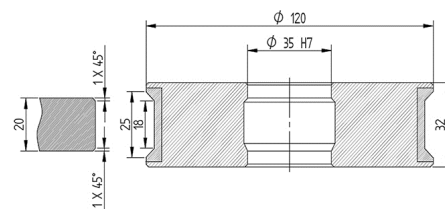

PRIX TOTAL DU SET:2.485,00 €

X30 26x33

POS	D	ID	H	TYPE D'ARTICLE	CODE	PRIX
1	120	120	35	Gros secteur	DGS70255	€ 522,00
2	120	114	35	Couronne continue ebauche	DGS77859	€ 589,00
3	120	114	35	Couronne continue medium	DGS77860	€ 589,00
4	120	114	35	Couronne continue fine	DGS77861	€ 589,00
5	67	60	35	Flash Bleu	DLG30145	€ 189,00 *
6	67	60	35	Flash Blanche	DLG30146	€ 189,00 *
7	67	60	35	Flash Grise	DLG30147	€ 189,00 *

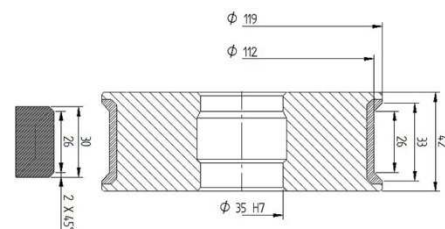

PRIX TOTAL DU SET:2.856,00 €

X40 36x43

POS	D	ID	H	TYPE D'ARTICLE	CODE	PRIX
1	120	120	35	Gros secteur	DGS70496	€ 624,00
2	120	120	35	Couronne continue ebauche	DGS79717	€ 681,00
3	120	120	35	Couronne continue medium	DGS79718	€ 681,00
4	120	120	35	Couronne continue fine	DGS79719	€ 681,00
5	69	60	35	Flash Bleu	DLG30148	€ 237,00 *
6	69	60	35	Flash Blanche	DLG30149	€ 237,00 *
7	69	60	35	Flash Grise	DLG30150	€ 237,00 *

PRIX TOTAL DU SET:3.378,00 €

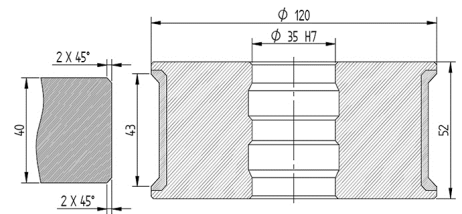

Z22

POS	D	ID	H	TYPE D'ARTICLE	CODE	PRIX
1	120	120	35	Gros secteur	DGS72707	€ 454,00
2	120	120	35	Couronne continue ebauche	DGS71202	€ 439,00
3	120	120	35	Couronne continue medium	DGS71203	€ 439,00
4	120	120	35	Couronne continue fine	DGS71204	€ 439,00
5	60	60	35	Flash Bleu	DLG31220	€ 196,00 *
6	60	60	35	Flash Blanche	DLG31221	€ 196,00 *
7	60	60	35	Flash Grise	DLG31222	€ 196,00 *

PRIX TOTAL DU SET:2.359,00 €

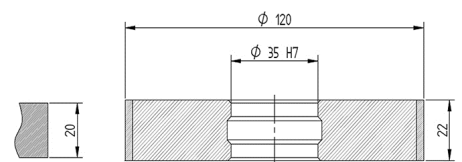

Z33

POS	D	ID	H	TYPE D'ARTICLE	CODE	PRIX
1	120	120	35	Gros secteur	DGS70255	€ 522,00
2	120	120	35	Couronne continue ebauche	DGS70972	€ 530,00
3	120	120	35	Couronne continue medium	DGS70973	€ 530,00
4	120	120	35	Couronne continue fine	DGS70974	€ 530,00
5	70	70	35	Flash Bleu	DLG30433	€ 243,00 *
6	70	70	35	Flash Blanche	DLG30434	€ 243,00 *
7	80	80	35	Flash Grise	DLG30435	€ 243,00 *

PRIX TOTAL DU SET:2.841,00 €

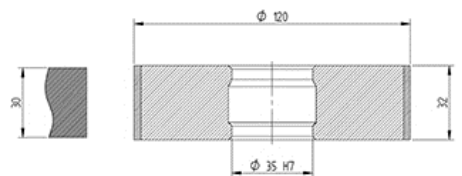

Z43

POS	D	ID	H	TYPE D'ARTICLE	CODE	PRIX
1	120	120	35	Gros secteur	DGS70496	€ 624,00
2	120	120	35	Couronne continue ebauche	DGS71463	€ 678,00
3	120	120	35	Couronne continue medium	DGS71464	€ 678,00
4	120	120	35	Couronne continue fine	DGS71465	€ 678,00
5	80	80	35	Flash Bleu	DLG30097	€ 258,00 *
6	80	80	35	Flash Blanche	DLG30098	€ 258,00 *
7	80	80	35	Flash Grise	DLG30099	€ 258,00 *

PRIX TOTAL DU SET:3.432,00 €

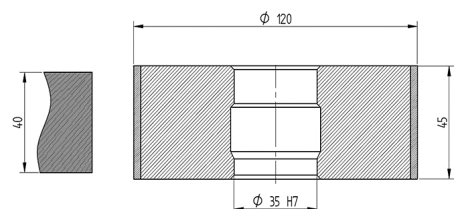











Meules diamètre 80 mm

Profils disponibles sur le catalogue



Profil ferme

PROFIL	SPÉCIFICATION DU PROFIL	PROFIL	SPÉCIFICATION DU PROFIL
	A A23 R6 A33 R6 A33 R20 A23 R10 A33 R10 A43 R6 A35 R15		AFR AFR33 R6 R3
	AK2 AK2 33 R30 AK2 43 R40		AK2R AK2R 33 R30 R55
	E E23 B8 E33 B8 h.25 E33 B11,5 E43 B8 E43 B11,5		EFR EFR33 B11,5 R4
	SK19 SK19 33		T T23 R3 T23 R6 T33 R3 T32 R6 T42 R6
	X X20 18x25 X30 26x33		Z Z22 Z63 Z33 Z45

Parametres de travail –KPL:

POS	D	TYPE D'ARTICLE	RPM	AVANCE (mm/min)	ENLEVEMENT (mm)
1	80	Gros secteur	6000	800-1200	2
2	80	Curonne continue ebauche	6000	1800-2500	0,4
3	80	Couronne continue medium	6000	1800-2500	0,2
4	80	Couronne continue fine	6000	800-1500	0,1-0,05
5	80	Flash bleu 60 mm	2700	1000-1500	0,05
6	80	flash blanche 60 mm	2700	1000-1500	0,05
7	80	Flash grise 60 mm	2700	1000-1500	0,05

A23 R6

POS	D	ID	H	TYPE D'ARTICLE	CODE	PRIX
1	80	67	35	Gros secteur	DGS82291	€ 317,00
2	80	67	35	Couronne continue ebauche	DGS82292	€ 337,00
3	80	67	35	Couronne continue medium	DGS82293	€ 337,00
4	80	67	35	Couronne continue fine	DGS82294	€ 337,00
5	73	60	35	Flash Bleu	DLG30767	€ 173,00 *
6	73	60	35	Flash Blanche	DLG30768	€ 173,00 *
7	73	60	35	Flash Grise	DLG30769	€ 173,00 *

PRIX TOTAL DU SET:1.847,00 €

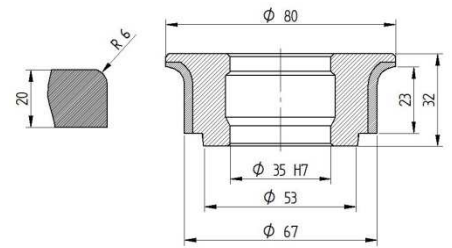

A23 R10

POS	D	ID	H	TYPE D'ARTICLE	CODE	PRIX
1	80	60	35	Gros secteur	DGS74440	€ 318,00
2	80	60	35	Couronne continue ebauche	DGS74082	€ 335,00
3	80	60	35	Couronne continue medium	DGS74083	€ 335,00
4	80	60	35	Couronne continue fine	DGS74084	€ 335,00
5	80	60	35	Flash Bleu	DLG30280	€ 173,00 *
6	80	60	35	Flash Blanche	DLG30281	€ 173,00 *
7	80	60	35	Flash Grise	DLG30282	€ 173,00 *

PRIX TOTAL DU SET:1.842,00 €

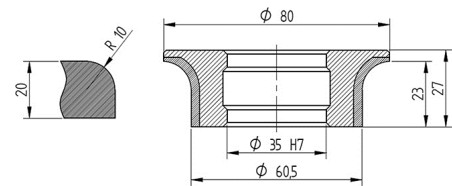

A33 R6

POS	D	ID	H	TYPE D'ARTICLE	CODE	PRIX
1	80	64	35	Gros secteur	DGS72878	€ 432,00
2	80	64	35	Couronne continue ebauche	DGS72879	€ 409,00
3	80	64	35	Couronne continue medium	DGS72880	€ 409,00
4	80	64	35	Couronne continue fine	DGS72881	€ 409,00
5	76	60	35	Flash Bleu	DLG30682	€ 189,00 *
6	76	60	35	Flash Blanche	DLG30683	€ 189,00 *
7	76	60	35	Flash Grise	DLG30684	€ 189,00 *

PRIX TOTAL DU SET:2.226,00 €

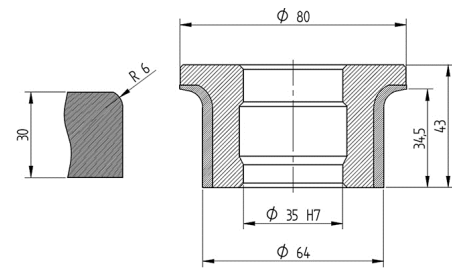

A33 R10

POS	D	ID	H	TYPE D'ARTICLE	CODE	PRIX
1	80	61	35	Gros secteur	DGS82037	€ 363,00
2	80	61	35	Couronne continue ebauche	DGS75504	€ 396,00
3	80	61	35	Couronne continue medium	DGS75505	€ 396,00
4	80	61	35	Couronne continue fine	DGS75506	€ 396,00
5	79	60	35	Flash Bleu	DLG30655	€ 189,00 *
6	79	60	35	Flash Blanche	DLG30656	€ 189,00 *
7	79	60	35	Flash Grise	DLG30657	€ 189,00 *

PRIX TOTAL DU SET:2.118,00 €

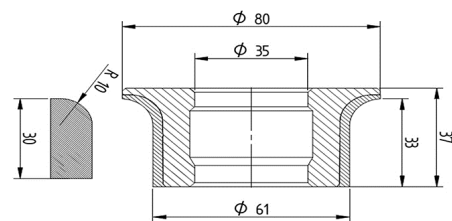

A33 R20

POS	D	ID	H	TYPE D'ARTICLE	CODE	PRIX
1	80	42	22	Gros secteur	DGS77071	€ 399,00
2	80	42	22	Couronne continue ebauche	DGS75318	€ 422,00
3	80	42	22	Couronne continue medium	DGS75319	€ 422,00
4	80	42	22	Couronne continue fine	DGS75320	€ 422,00
5	80	40	22	Flash Bleu	DLG31730	€ 194,00 *
6	80	40	22	Flash Blanche	DLG31731	€ 194,00 *
7	80	40	22	Flash Grise	DLG31732	€ 194,00 *

PRIX TOTAL DU SET: 2.247,00 €

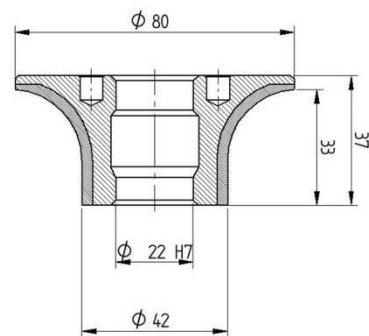

A35 R15

POS	D	ID	H	TYPE D'ARTICLE	CODE	PRIX
1	80	52	35	Gros secteur	DGS77977	€ 329,00
2	80	52	35	Couronne continue ebauche	DGS72692	€ 380,00
3	80	52	35	Couronne continue medium	DGS72693	€ 380,00
4	80	52	35	Couronne continue fine	DGS72694	€ 380,00
5	80	52	35	Flash Bleu	DLG30346	€ 194,00 *
6	80	52	35	Flash Blanche	DLG30347	€ 194,00 *
7	80	52	35	Flash Grise	DLG30348	€ 194,00 *

PRIX TOTAL DU SET: 2.051,00 €

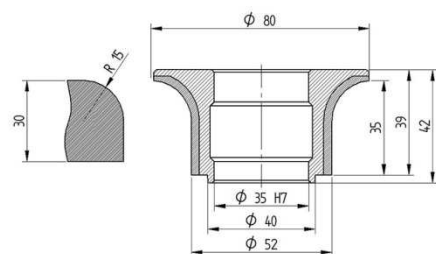

A35 R15

POS	D	ID	H	TYPE D'ARTICLE	CODE	PRIX
1	80	52	22	Gros secteur	DGS72548	€ 329,00
2	80	52	22	Couronne continue ebauche	DGS72549	€ 380,00
3	80	52	22	Couronne continue medium	DGS72550	€ 380,00
4	80	52	22	Couronne continue fine	DGS72551	€ 380,00
5	80	52	22	Flash Bleu	DLG30217	€ 194,00 *
6	80	52	22	Flash Blanche	DLG30218	€ 194,00 *
7	80	52	22	Flash Grise	DLG30219	€ 194,00 *

PRIX TOTAL DU SET: 2.051,00 €

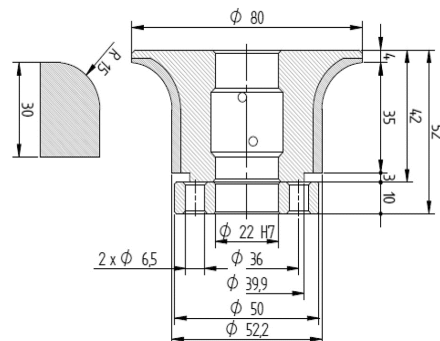

A43 R6

POS	D	ID	H	TYPE D'ARTICLE	CODE	PRIX
1	80	64	35	Gros secteur	DGS81145	€ 516,00
2	80	64	35	Couronne continue ebauche	DGS81146	€ 584,00
3	80	64	35	Couronne continue medium	DGS81147	€ 584,00
4	80	64	35	Couronne continue fine	DGS81148	€ 584,00
5	76	60	35	Flash Bleu	DLG30034	€ 211,00 *
6	76	60	35	Flash Blanche	DLG30035	€ 211,00 *
7	76	60	35	Flash Grise	DLG30036	€ 211,00 *

PRIX TOTAL DU SET: 2.901,00 €

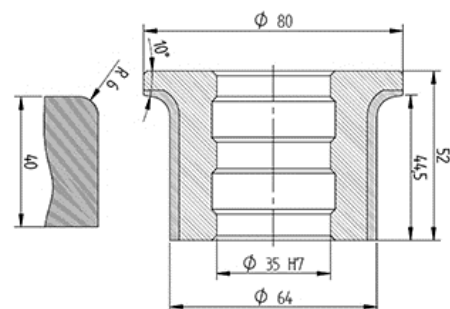

AFR33 R6 R3

POS	D	ID	H	TYPE D'ARTICLE	CODE	PRIX
1	80	64	35	Gros secteur	DGS72878	€ 432,00
2	80	72	35	Couronne continue ebauche	DGS77020	€ 409,00
3	80	72	35	Couronne continue medium	DGS77021	€ 409,00
4	80	72	35	Couronne continue fine	DGS77022	€ 409,00
5	76	60	35	Flash Bleu	DLG30685	€ 211,00 *
6	76	60	35	Flash Blanche	DLG30686	€ 211,00 *
7	76	60	35	Flash Grise	DLG30687	€ 211,00 *

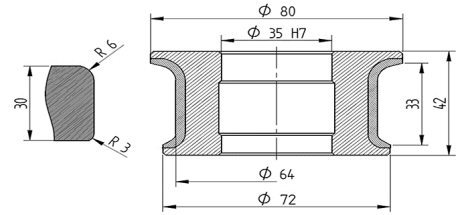

PRIX TOTAL DU SET:2.292,00 €

AK2 33 R30

POS	D	ID	H	TYPE D'ARTICLE	CODE	PRIX
1	80	70	35	Gros secteur	DGS77079	€ 348,00
2	80	70	35	Couronne continue ebauche	DGS77080	€ 405,00
3	80	70	35	Couronne continue medium	DGS77081	€ 405,00
4	80	70	35	Couronne continue fine	DGS77082	€ 405,00
5	70	60	35	Flash Bleu	DLG30658	€ 189,00 *
6	70	60	35	Flash Blanche	DLG30659	€ 189,00 *
7	70	60	35	Flash Grise	DLG30660	€ 189,00 *

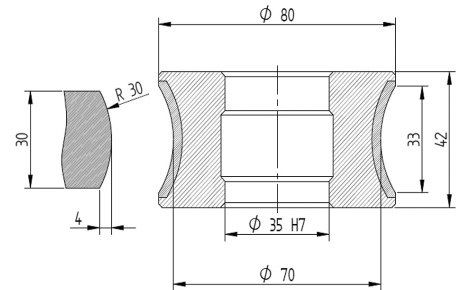

PRIX TOTAL DU SET:2.130,00 €

AK2R 33 R30 R5

POS	D	ID	H	TYPE D'ARTICLE	CODE	PRIX
1	80	63	35	Gros secteur	DGS76525	€ 492,00
2	80	63	35	Couronne continue ebauche	DGS76526	€ 535,00
3	80	63	35	Couronne continue medium	DGS76527	€ 535,00
4	80	63	35	Couronne continue fine	DGS76528	€ 535,00
5	77	60	35	Flash Bleu	DLG31324	€ 228,00 *
6	77	60	35	Flash Blanche	DLG31325	€ 228,00 *
7	77	60	35	Flash Grise	DLG31326	€ 228,00 *

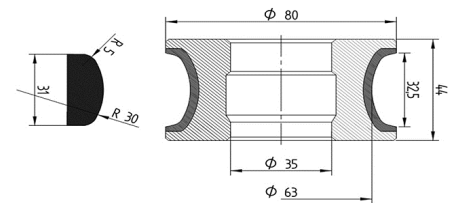

PRIX TOTAL DU SET:2.781,00 €

AK2 43 R40

POS	D	ID	H	TYPE D'ARTICLE	CODE	PRIX
1	80	67	35	Gros secteur	DGS77083	€ 522,00
2	80	67	35	Couronne continue ebauche	DGS77084	€ 556,00
3	80	67	35	Couronne continue medium	DGS77085	€ 556,00
4	80	67	35	Couronne continue fine	DGS77086	€ 556,00
5	73	60	35	Flash Bleu	DLG30809	€ 212,00 *
6	73	60	35	Flash Blanche	DLG30810	€ 212,00 *
7	73	60	35	Flash Grise	DLG30811	€ 212,00 *

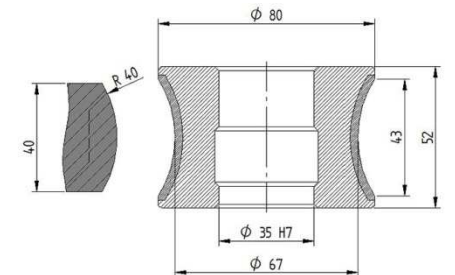

PRIX TOTAL DU SET:2.826,00 €

E23 B8

POS	D	ID	H	TYPE D'ARTICLE	CODE	PRIX
1	80	64	35	Gros secteur	DGS82304	€ 387,00
2	80	64	35	Couronne continue ebauche	DGS82305	€ 417,00
3	80	64	35	Couronne continue medium	DGS82306	€ 417,00
4	80	64	35	Couronne continue fine	DGS82307	€ 417,00
5	76	60	35	Flash Bleu	DLG30803	€ 173,00 *
6	76	60	35	Flash Blanche	DLG30804	€ 173,00 *
7	76	60	35	Flash Grise	DLG30805	€ 173,00 *

PRIX TOTAL DU SET:2.157,00 €

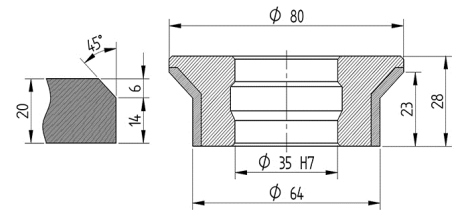
E33 B8 h.25

POS	D	ID	H	TYPE D'ARTICLE	CODE	PRIX
1	80	64	35	Gros secteur	DGS76258	€ 442,00
2	80	64	35	Couronne continue ebauche	DGS74226	€ 420,00
3	80	64	35	Couronne continue medium	DGS74187	€ 420,00
4	80	64	35	Couronne continue fine	DGS74188	€ 420,00
5	76	60	35	Flash Bleu	DLG30241	€ 228,00 *
6	76	60	35	Flash Blanche	DLG30242	€ 228,00 *
7	76	60	35	Flash Grise	DLG30243	€ 228,00 *

PRIX TOTAL DU SET:2.386,00 €

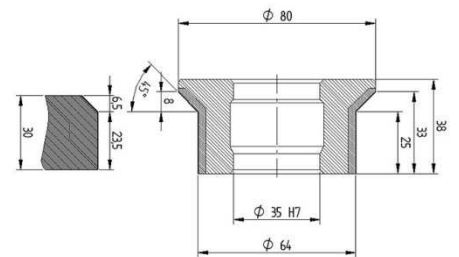
E33 B11,5

POS	D	ID	H	TYPE D'ARTICLE	CODE	PRIX
1	80	57	35	Gros secteur	DGS75827	€ 386,00
2	80	57	35	Couronne continue ebauche	DGS75828	€ 434,00
3	80	57	35	Couronne continue medium	DGS75829	€ 434,00
4	80	57	35	Couronne continue fine	DGS75830	€ 434,00
5	83	60	35	Flash Bleu	DLG30121	€ 196,00 *
6	83	60	35	Flash Blanche	DLG30122	€ 196,00 *
7	83	60	35	Flash Grise	DLG30123	€ 196,00 *

PRIX TOTAL DU SET:2.276,00 €

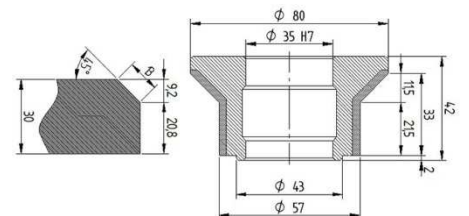
E43 B8

POS	D	ID	H	TYPE D'ARTICLE	CODE	PRIX
1	80	64	35	Gros secteur	DGS76392	€ 442,00
2	80	64	35	Couronne continue ebauche	DGS76393	€ 505,00
3	80	64	35	Couronne continue medium	DGS76394	€ 505,00
4	80	64	35	Couronne continue fine	DGS76395	€ 505,00
5	76	60	35	Flash Bleu	DLG30839	€ 212,00 *
6	76	60	35	Flash Blanche	DLG30840	€ 212,00 *
7	76	60	35	Flash Grise	DLG30841	€ 212,00 *

PRIX TOTAL DU SET:2.593,00 €

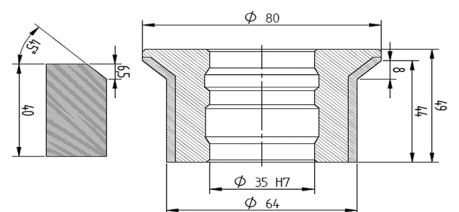

E43 B11,5

POS	D	ID	H	TYPE D'ARTICLE	CODE	PRIX
1	80	57	35	Gros secteur	DGS75524	€ 482,00
2	80	57	35	Couronne continue ebauche	DGS75525	€ 545,00
3	80	57	35	Couronne continue medium	DGS75526	€ 545,00
4	80	57	35	Couronne continue fine	DGS75527	€ 545,00
5	83	60	35	Flash Bleu	DLG30670	€ 212,00 *
6	83	60	35	Flash Blanche	DLG30671	€ 212,00 *
7	83	60	35	Flash Grise	DLG30672	€ 212,00 *

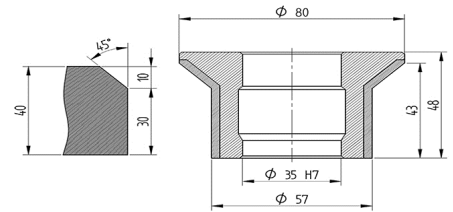

PRIX TOTAL DU SET:2.753,00 €

EFR33 B11,5 R4

POS	D	ID	H	TYPE D'ARTICLE	CODE	PRIX
1	80	57	35	Gros secteur	DGS75827	€ 386,00
2	80	57	35	Couronne continue ebauche	DGS79583	€ 546,00
3	80	57	35	Couronne continue medium	DGS79584	€ 546,00
4	80	57	35	Couronne continue fine	DGS79585	€ 546,00
5	83	60	35	Flash Bleu	DLG30631	€ 250,00 *
6	83	60	35	Flash Blanche	DLG30632	€ 250,00 *
7	83	60	35	Flash Grise	DLG30633	€ 250,00 *

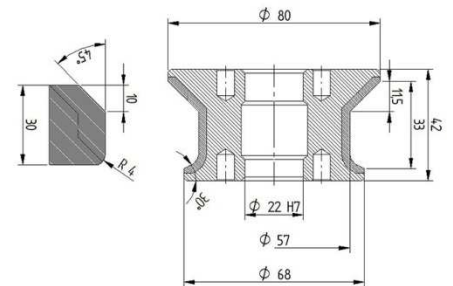

PRIX TOTAL DU SET:2.774,00 €

SK19 33

POS	D	ID	H	TYPE D'ARTICLE	CODE	PRIX
1	80	70	35	Gros secteur	DGS78113	€ 411,00
2	80	70	35	Couronne continue ebauche	DGS78114	€ 411,00
3	80	70	35	Couronne continue medium	DGS78115	€ 411,00
4	80	70	35	Couronne continue fine	DGS78116	€ 411,00
5	70	60	35	Flash Bleu	DLG30520	€ 320,00 *
6	70	60	35	Flash Blanche	DLG30521	€ 320,00 *
7	70	60	35	Flash Grise	DLG30522	€ 320,00 *

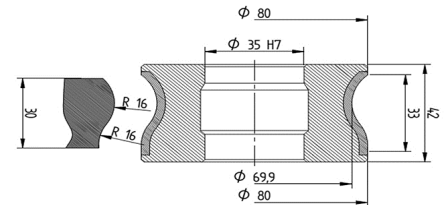

PRIX TOTAL DU SET:2.604,00 €

T23 R3

POS	D	ID	H	TYPE D'ARTICLE	CODE	PRIX
1	80	80	35	Gros secteur	DGS74430	€ 386,00
2	80	73	35	Couronne continue ebauche	DGS74431	€ 358,00
3	80	73	35	Couronne continue medium	DGS74432	€ 358,00
4	80	73	35	Couronne continue fine	DGS74433	€ 358,00
5	67	60	35	Flash Bleu	DLG30006	€ 172,00 *
6	67	60	35	Flash Blanche	DLG30007	€ 172,00 *
7	67	60	35	Flash Grise	DLG30008	€ 172,00 *

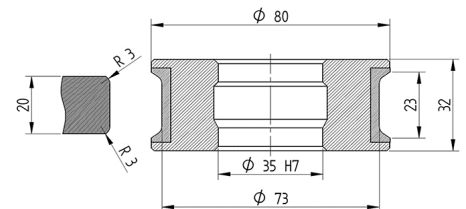

PRIX TOTAL DU SET:1.976,00 €

T23 R6

POS	D	ID	H	TYPE D'ARTICLE	CODE	PRIX
1	80	68	35	Gros secteur	DGS81056	€ 348,00
2	80	68	35	Couronne continue ebauche	DGS81057	€ 420,00
3	80	68	35	Couronne continue medium	DGS81058	€ 420,00
4	80	68	35	Couronne continue fine	DGS81059	€ 420,00
5	72	60	35	Flash Bleu	DLG31142	€ 173,00 *
6	72	60	35	Flash Blanche	DLG31143	€ 173,00 *
7	72	60	35	Flash Grise	DLG31144	€ 173,00 *

PRIX TOTAL DU SET: 2.127,00 €

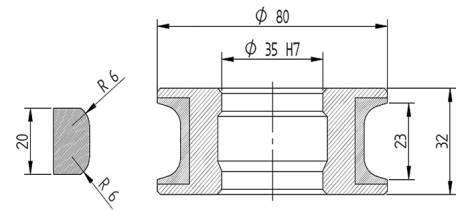

T33 R3

POS	D	ID	H	TYPE D'ARTICLE	CODE	PRIX
1	80	80	35	Gros secteur	DGS71189	€ 454,00
2	80	73	35	Couronne continue ebauche	DGS72808	€ 397,00
3	80	73	35	Couronne continue medium	DGS72809	€ 397,00
4	80	73	35	Couronne continue fine	DGS72810	€ 397,00
5	67	60	35	Flash Bleu	DLG30133	€ 189,00 *
6	67	60	35	Flash Blanche	DLG30134	€ 189,00 *
7	67	60	35	Flash Grise	DLG30135	€ 189,00 *

PRIX TOTAL DU SET: 2.212,00 €

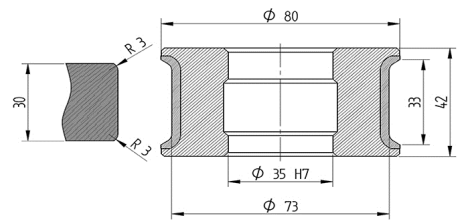

T32 R6

POS	D	ID	H	TYPE D'ARTICLE	CODE	PRIX
1	80	64	35	Gros secteur	DGS74008	€ 454,00
2	80	64	35	Couronne continue ebauche	DGS74009	€ 476,00
3	80	64	35	Couronne continue medium	DGS74010	€ 476,00
4	80	64	35	Couronne continue fine	DGS74011	€ 476,00
5	76	60	35	Flash Bleu	DLG30646	€ 200,00 *
6	76	60	35	Flash Blanche	DLG30647	€ 200,00 *
7	76	60	35	Flash Grise	DLG30648	€ 200,00 *

PRIX TOTAL DU SET: 2.482,00 €

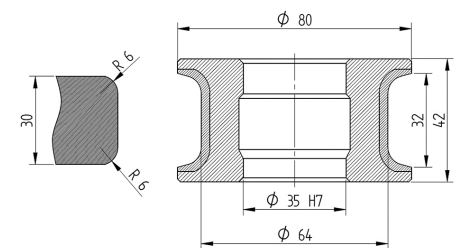

T42 R6

POS	D	ID	H	TYPE D'ARTICLE	CODE	PRIX
1	80	66	35	Gros secteur	DGS84082	€ 420,00
2	80	66	35	Couronne continue ebauche	DGS84083	€ 484,00
3	80	66	35	Couronne continue medium	DGS84084	€ 484,00
4	80	66	35	Couronne continue fine	DGS84085	€ 484,00
5	74	60	35	Flash Bleu	DLG31748	€ 256,00 *
6	74	60	35	Flash Blanche	DLG31749	€ 256,00 *
7	74	60	35	Flash Grise	DLG31750	€ 256,00 *

PRIX TOTAL DU SET: 2.640,00 €

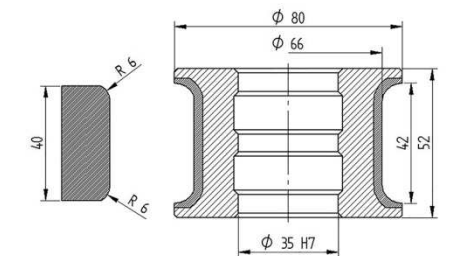

T43 R3

POS	D	ID	H	TYPE D'ARTICLE	CODE	PRIX
1	80	80	35	Gros secteur	DGS72597	€ 476,00
2	80	74	35	Couronne continue ebauche	DGS71697	€ 483,00
3	80	74	35	Couronne continue medium	DGS71698	€ 483,00
4	80	74	35	Couronne continue fine	DGS71699	€ 483,00
5	67	60	35	Flash Bleu	DLG30313	€ 288,00 *
6	67	60	35	Flash Blanche	DLG30314	€ 288,00 *
7	67	60	35	Flash Grise	DLG30315	€ 288,00 *

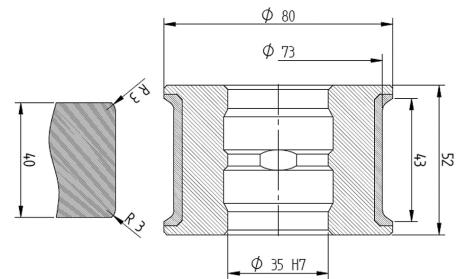

PRIX TOTAL DU SET: 2.789,00 €

X20 18x25

POS	D	ID	H	TYPE D'ARTICLE	CODE	PRIX
1	80	80	35	Gros secteur	DGS74430	€ 386,00
2	80	74	35	Couronne continue ebauche	DGS81414	€ 375,00
3	80	74	35	Couronne continue medium	DGS81415	€ 375,00
4	80	74	35	Couronne continue fine	DGS81416	€ 375,00
5	67	60	35	Flash Bleu	DLG30142	€ 192,00 *
6	67	60	35	Flash Blanche	DLG30143	€ 192,00 *
7	67	60	35	Flash Grise	DLG30144	€ 192,00 *

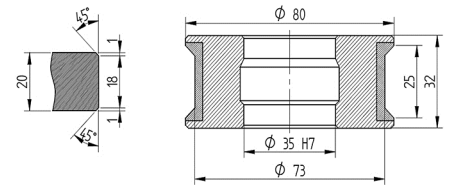

PRIX TOTAL DU SET: 2.087,00 €

X30 26x33

POS	D	ID	H	TYPE D'ARTICLE	CODE	PRIX
1	80	80	35	Gros secteur	DGS77755	€ 454,00
2	80	73	35	Couronne continue ebauche	DGS77756	€ 442,00
3	80	73	35	Couronne continue medium	DGS77757	€ 442,00
4	80	73	35	Couronne continue fine	DGS77758	€ 442,00
5	67	60	35	Flash Bleu	DLG30145	€ 189,00 *
6	67	60	35	Flash Blanche	DLG30146	€ 189,00 *
7	67	60	35	Flash Grise	DLG30147	€ 189,00 *

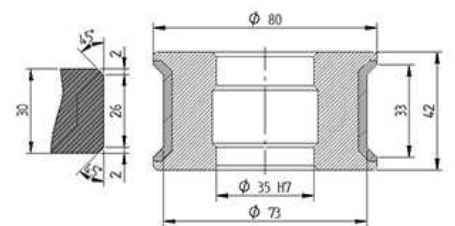

PRIX TOTAL DU SET: 2.347,00 €

Z22

POS	D	ID	H	TYPE D'ARTICLE	CODE	PRIX
1	80	80	35	Gros secteur	DGS74430	€ 386,00
2	80	80	35	Couronne continue ebauche	DGS74302	€ 346,00
3	80	80	35	Couronne continue medium	DGS74303	€ 346,00
4	80	80	35	Couronne continue fine	DGS74304	€ 346,00
5	60	60	35	Flash Bleu	DLG31220	€ 196,00 *
6	60	60	35	Flash Blanche	DLG31221	€ 196,00 *
7	60	60	35	Flash Grise	DLG31222	€ 196,00 *

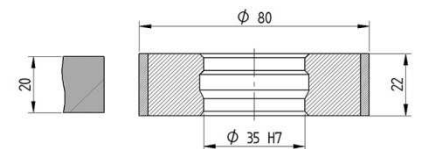

PRIX TOTAL DU SET: 2.012,00 €

Z33

POS	D	ID	H	TYPE D'ARTICLE	CODE	PRIX
1	80	80	35	Gros secteur	DGS71189	€ 454,00
2	80	80	35	Couronne continue ebauche	DGS72804	€ 420,00
3	80	80	35	Couronne continue medium	DGS72805	€ 420,00
4	80	80	35	Couronne continue fine	DGS72806	€ 420,00
5	60	60	35	Flash Bleu	DLG30478	€ 228,00 *
6	60	60	35	Flash Blanche	DLG30479	€ 228,00 *
7	60	60	35	Flash Grise	DLG30480	€ 228,00 *

PRIX TOTAL DU SET:2.398,00 €

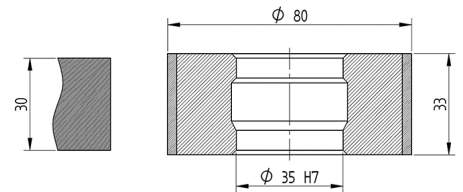

Z45

POS	D	ID	H	TYPE D'ARTICLE	CODE	PRIX
1	80	80	35	Gros secteur	DGS72597	€ 476,00
2	80	80	35	Couronne continue ebauche	DGS71466	€ 471,00
3	80	80	35	Couronne continue medium	DGS71467	€ 471,00
4	80	80	35	Couronne continue fine	DGS71468	€ 471,00
5	60	60	35	Flash Bleu	DLG30322	€ 226,00 *
6	60	60	35	Flash Blanche	DLG30323	€ 226,00 *
7	60	60	35	Flash Grise	DLG30324	€ 226,00 *

PRIX TOTAL DU SET:2.567,00 €

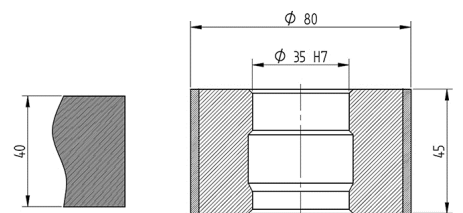

Z45

POS	D	ID	H	TYPE D'ARTICLE	CODE	PRIX
1	80	80	22	Gros secteur	DGS70716	€ 476,00
2	80	80	22	Couronne continue ebauche	DGS71767	€ 471,00
3	80	80	22	Couronne continue medium	DGS71768	€ 471,00
4	80	80	22	Couronne continue fine	DGS71769	€ 471,00
5	60	60	22	Flash Bleu	DLG30100	€ 226,00 *
6	60	60	22	Flash Blanche	DLG30101	€ 226,00 *
7	60	60	22	Flash Grise	DLG30102	€ 226,00 *

PRIX TOTAL DU SET:2.567,00 €

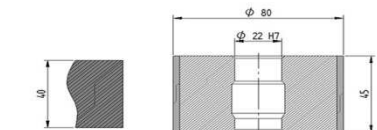

Z65

POS	D	ID	H	TYPE D'ARTICLE	CODE	PRIX
1	80	80	35	Gros secteur	DGS76012	€ 579,00
2	80	80	35	Couronne continue ebauche	DGS76013	€ 624,00
3	80	80	35	Couronne continue medium	DGS76014	€ 624,00
4	80	80	35	Couronne continue fine	DGS76015	€ 624,00
5	80	80	35	Flash Bleu	DLG30418	€ 308,00 *
6	80	80	35	Flash Blanche	DLG30419	€ 308,00 *
7	80	80	35	Flash Grise	DLG30420	€ 308,00 *

PRIX TOTAL DU SET:3.375,00 €

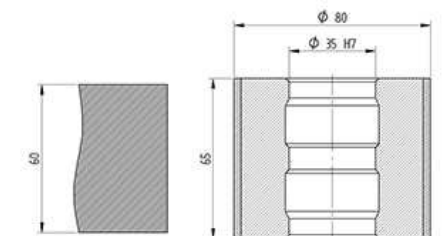



Meules diamètre 60 mm

Profils disponibles sur le catalogue



Profil fermé

PROFIL	SPÉCIFICATION DU PROFIL	PROFIL	SPÉCIFICATION DU PROFIL
	AFR AFR33 R6 R3		Z Z33 Z45
	T T23 R3 T32 R6 T33 R3		

Parametres de travail –KPL:

POS	D	TYPE D'ARTICLE	RPM	AVANCE (mm/min)	ENLEVEMENT (mm)
1	60	Couronne continue ebauche	6000	500-800	2
2	60	Couronne continue ebauche	6500	1500-2000	0,4
3	60	Couronne continue medium	6500	1500-2000	0,2
4	60	Couronne continue fine	6000	1000-1500	0,1-0,05
5	60	Flash bleu 60 mm	2700	1000-1500	0,05
6	60	Flash blanche 60 mm	2700	1000-1500	0,05
7	60	Flash grise 60 mm	2700	1000-1500	0,05

AFR33 R6 R3

POS	D	ID	H	TYPE D'ARTICLE	CODE	PRIX
1	60	46	22	Couronne continue ebauche	DGS77942	€ 365,00
2	60	46	22	Couronne continue ebauche	DGS77924	€ 365,00
3	60	46	22	Couronne continue medium	DGS77925	€ 365,00
4	60	46	22	Couronne continue fine	DGS77926	€ 365,00
5	60	45	22	Flash Bleu	DLG31484	€ 196,00 *
6	60	45	22	Flash Blanche	DLG31485	€ 196,00 *
7	60	45	22	Flash Grise	DLG31486	€ 196,00 *

PRIX TOTAL DU SET: 2.048,00 €

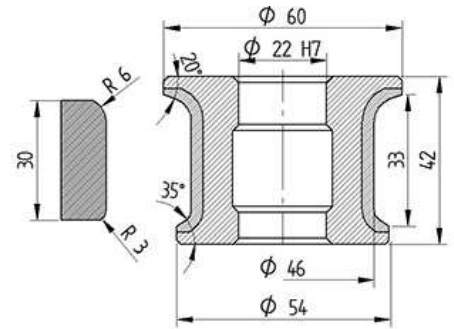

T23 R3

POS	D	ID	H	TYPE D'ARTICLE	CODE	PRIX
1	60	60	22	Gros secteur	DGS70897	€ 318,00
2	60	53	22	Couronne continue ebauche	DGS71770	€ 306,00
3	60	53	22	Couronne continue medium	DGS71771	€ 306,00
4	60	53	22	Couronne continue fine	DGS71772	€ 306,00
5	57	50	22	Flash Bleu	DLG30166	€ 180,00 *
6	57	50	22	Flash Blanche	DLG30167	€ 180,00 *
7	57	50	22	Flash Grise	DLG30168	€ 180,00 *

PRIX TOTAL DU SET: 1.776,00 €

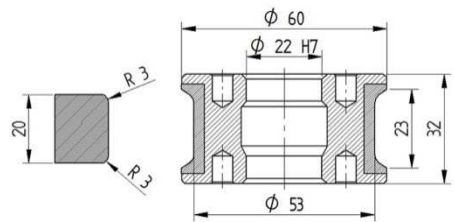

T32 R6

POS	D	ID	H	TYPE D'ARTICLE	CODE	PRIX
1	60	44	22	Couronne continue ebauche	DGS80018	€ 418,00
2	60	44	22	Couronne continue ebauche	DGS80007	€ 418,00
3	60	44	22	Couronne continue medium	DGS80008	€ 418,00
4	60	44	22	Couronne continue medium	DGS80009	€ 418,00
5	56	40	22	Flash Bleu	DLG30583	€ 200,00 *
6	56	40	22	Flash Blanche	DLG30584	€ 200,00 *
7	56	40	22	Flash Grise	DLG30585	€ 200,00 *

PRIX TOTAL DU SET: 2.272,00 €

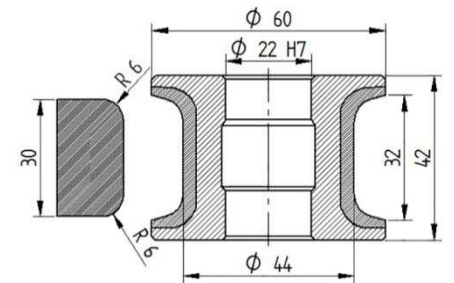

T33 R3

POS	D	ID	H	TYPE D'ARTICLE	CODE	PRIX
1	60	53	22	Gros secteur	DGS74021	€ 365,00
2	60	53	22	Couronne continue ebauche	DGS71280	€ 365,00
3	60	53	22	Couronne continue medium	DGS71281	€ 365,00
4	60	53	22	Couronne continue fine	DGS71282	€ 365,00
5	57	50	22	Flash Bleu	DLG30169	€ 189,00 *
6	57	50	22	Flash Blanche	DLG30170	€ 189,00 *
7	57	50	22	Flash Grise	DLG30171	€ 189,00 *

PRIX TOTAL DU SET: 2.027,00 €

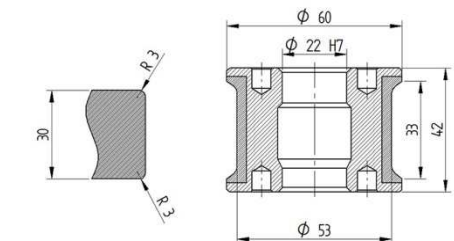

Z33

POS	D	ID	H	TYPE D'ARTICLE	CODE	PRIX
1	60	60	35	Gros secteur	DGS71833	€ 363,00
2	60	60	35	Couronne continue ebauche	DGS75589	€ 355,00
3	60	60	35	Couronne continue medium	DGS75590	€ 355,00
4	60	60	35	Couronne continue fine	DGS75591	€ 355,00
5	60	60	35	Flash Bleu	DLG30478	€ 228,00 *
6	60	60	35	Flash Blanche	DLG30479	€ 228,00 *
7	60	60	35	Flash Grise	DLG30480	€ 228,00 *

PRIX TOTAL DU SET:2.112,00 €

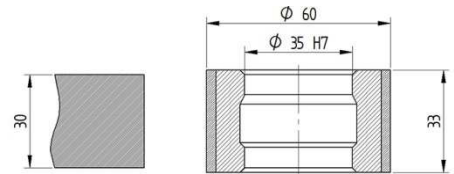
Z45

POS	D	ID	H	TYPE D'ARTICLE	CODE	PRIX
1	60	60	35	Couronne continue ebauche	DGS76206	€ 423,00
2	60	60	35	Couronne continue ebauche	DGS74373	€ 375,00
3	60	60	35	Couronne continue medium	DGS76207	€ 375,00
4	60	60	35	Couronne continue fine	DGS76208	€ 375,00
5	60	60	35	Flash Bleu	DLG30322	€ 226,00 *
6	60	60	35	Flash Blanche	DLG30323	€ 226,00 *
7	60	60	35	Flash Grise	DLG30324	€ 226,00 *

PRIX TOTAL DU SET:2.226,00 €

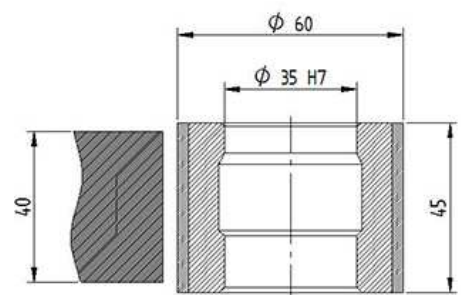
Z45

POS	D	ID	H	TYPE D'ARTICLE	CODE	PRIX
1	60	60	22	Couronne continue ebauche	DGS70828	€ 423,00
2	60	60	22	Couronne continue ebauche	DGS71547	€ 392,00
3	60	60	22	Couronne continue medium	DGS71548	€ 392,00
4	60	60	22	Couronne continue fine	DGS71549	€ 392,00
5	60	60	22	Flash Bleu	DLG30466	€ 226,00 *
6	60	60	22	Flash Blanche	DLG30467	€ 226,00 *
7	60	60	22	Flash Grise	DLG30468	€ 226,00 *

PRIX TOTAL DU SET:2.277,00 €

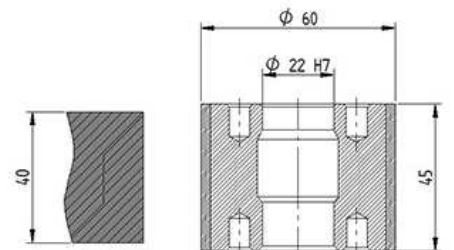





Meules diamètre 40 mm

Profils disponibles sur le catalogue



Profil ferme

SHAPE	SHAPE SPECIFICATION	SHAPE	SHAPE SPECIFICATION
	A A23 R6 A33 R3 A33 R6 A43 R6		E E36 B4
	T T23 R3 T33 R3		Z Z35 Z45

Parametres de travail –KPL:

POS	D	ID	TYPE D'ARTICLE	RPM	AVANCE (mm/min)	ENLEVEMENT (mm)
1	53	40	Couronne continue ebauche	6000	500-800	2
2	53	40	Couronne continue ebauche	6500	1500-2000	0,4
3	53	40	Couronne continue medium	6500	1500-2000	0,2
4	53	40	Couronne continue fine	6000	1000-1500	0,1-0,05
5	53	40	Flash bleu	2700	1000-1500	0,05
6	53	40	Flash blanche	2700	1000-1500	0,05
7	53	40	Flash grise	2700	1000-1500	0,05

A23 R6

POS	D	ID	H	TYPE D'ARTICLE	CODE	PRIX
1	53	40	22	Couronne continue ebauche	DGS77807	€ 374,00
2	53	40	22	Couronne continue ebauche	DGS78371	€ 374,00
3	53	40	22	Couronne continue medium	DGS78372	€ 374,00
4	53	40	22	Couronne continue fine	DGS78373	€ 374,00
5	53	40	22	Flash Bleu	DLG30815	€ 189,00 *
6	53	40	22	Flash Blanche	DLG30816	€ 189,00 *
7	53	40	22	Flash Grise	DLG30817	€ 189,00 *

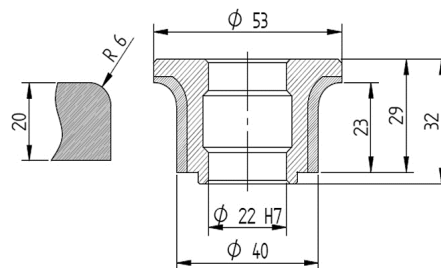

PRIX TOTAL DU SET: 2.063,00 €

A33 R3

POS	D	ID	H	TYPE D'ARTICLE	CODE	PRIX
1	40	33	22	Couronne continue ebauche	DGS77615	€ 366,00
2	40	33	22	Couronne continue ebauche	DGS77616	€ 366,00
3	40	33	22	Couronne continue medium	DGS77628	€ 366,00
4	40	33	22	Couronne continue fine	DGS77629	€ 366,00
5	40	33	22	Flash Bleu	DLG31291	€ 196,00 *
6	40	33	22	Flash Blanche	DLG31292	€ 196,00 *
7	40	33	22	Flash Grise	DLG31293	€ 196,00 *

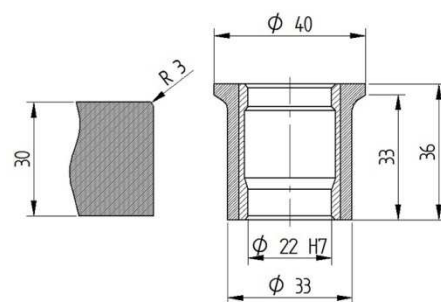

PRIX TOTAL DU SET: 2.052,00 €

A33 R6

POS	D	ID	H	TYPE D'ARTICLE	CODE	PRIX
1	53	40	22	Couronne continue ebauche	DGS78384	€ 387,00
2	53	40	22	Couronne continue ebauche	DGS74183	€ 355,00
3	53	40	22	Couronne continue medium	DGS74184	€ 355,00
4	53	40	22	Couronne continue fine	DGS74185	€ 355,00
5	53	40	22	Flash Bleu	DLG30818	€ 189,00 *
6	53	40	22	Flash Blanche	DLG30819	€ 189,00 *
7	53	40	22	Flash Grise	DLG30820	€ 189,00 *

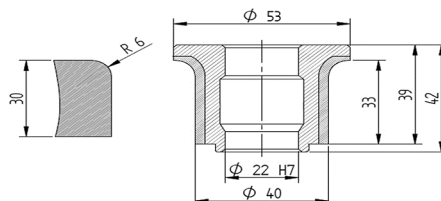

PRIX TOTAL DU SET: 2.019,00 €

A43 R6

POS	D	ID	H	TYPE D'ARTICLE	CODE	PRIX
1	53	40	22	Couronne continue ebauche	DGS82458	€ 407,00
2	53	40	22	Couronne continue ebauche	DGS82459	€ 407,00
3	53	40	22	Couronne continue medium	DGS82460	€ 407,00
4	53	40	22	Couronne continue fine	DGS82461	€ 407,00
5	53	40	22	Flash Bleu	DLG30821	€ 212,00 *
6	53	40	22	Flash Blanche	DLG30822	€ 212,00 *
7	53	40	22	Flash Grise	DLG30823	€ 212,00 *

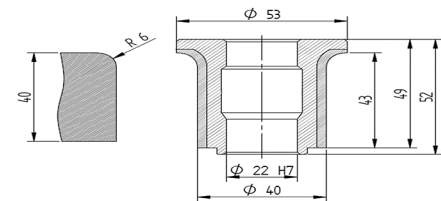

PRIX TOTAL DU SET: 2.264,00 €

E36 B4

POS	D	ID	H	TYPE D'ARTICLE	CODE	PRIX
1	39	31	22	Gros secteur	DGS83871	€ 375,00
2	39	31	22	Couronne continue ebauche	DGS83872	€ 375,00
3	39	31	22	Couronne continue medium	DGS83873	€ 375,00
4	39	31	22	Couronne continue fine	DGS83874	€ 375,00
5	41	33	22	Flash Bleu	DLG31630	€ 196,00 *
6	41	33	22	Flash Blanche	DLG31631	€ 196,00 *
7	41	33	22	Flash Grise	DLG31632	€ 196,00 *

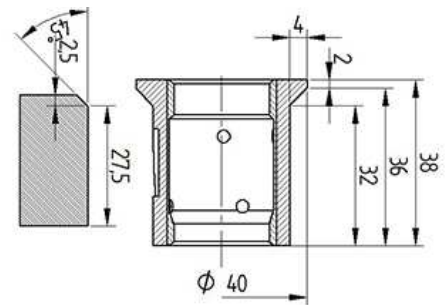

PRIX TOTAL DU SET:2.088,00 €

Polissage FLASH avec diamètre interieure 33 mm.

T23 R3

POS	D	ID	H	TYPE D'ARTICLE	CODE	PRIX
1	40	33	22	Gros secteur	DGS73204	€ 183,00
2	40	33	22	Couronne continue ebauche	DGS73205	€ 325,00
3	40	33	22	Couronne continue medium	DGS73206	€ 325,00
4	40	33	22	Couronne continue fine	DGS73207	€ 325,00
5	40	33	22	Flash Bleu	DLG31154	€ 176,00 *
6	40	33	22	Flash Blanche	DLG31155	€ 176,00 *
7	40	33	22	Flash Grise	DLG31156	€ 176,00 *

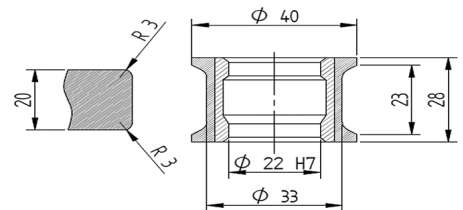

PRIX TOTAL DU SET:1.686,00 €

T33 R3

POS	D	ID	H	TYPE D'ARTICLE	CODE	PRIX
1	40	40	22	Gros secteur	DGS70810	€ 306,00
2	40	33	22	Couronne continue ebauche	DGS72297	€ 365,00
3	40	33	22	Couronne continue medium	DGS72298	€ 365,00
4	40	33	22	Couronne continue fine	DGS72299	€ 365,00
5	40	33	22	Flash Bleu	DLG31157	€ 194,00 *
6	40	33	22	Flash Blanche	DLG31158	€ 194,00 *
7	40	33	22	Flash Grise	DLG31159	€ 194,00 *

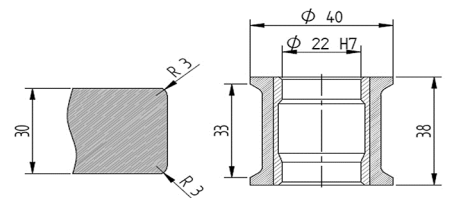

PRIX TOTAL DU SET:1.983,00 €

Z35

POS	D	ID	H	TYPE D'ARTICLE	CODE	PRIX
1	40	40	22	Gros secteur	DGS70810	€ 306,00
2	40	40	22	Couronne continue ebauche	DGS74919	€ 343,00
3	40	40	22	Couronne continue medium	DGS74920	€ 343,00
4	40	40	22	Couronne continue fine	DGS74921	€ 343,00
5	40	40	22	Flash Grise	DLG31105	€ 192,00 *
6	40	40	22	Flash Blanche	DLG31106	€ 192,00 *
7	40	40	22	Flash Grise	DLG31107	€ 192,00 *

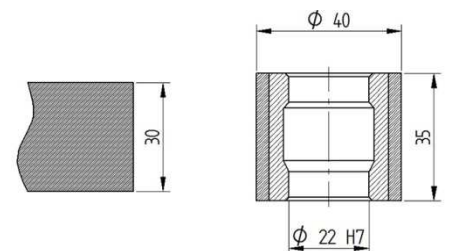

PRIX TOTAL DU SET:1.911,00 €

Z45

POS	D	ID	H	TYPE D'ARTICLE	CODE	PRIX
1	40	40	22	Gros secteur	DGS72004	€ 363,00
2	40	40	22	Couronne continue ébauche	DGS72137	€ 380,00
3	40	40	22	Couronne continue medium	DGS72138	€ 380,00
4	40	40	22	Couronne continue fine	DGS72139	€ 380,00
5	40	40	22	Flash Bleu	DLG31111	€ 212,00 *
6	40	40	22	Flash Blanche	DLG31112	€ 212,00 *
7	40	40	22	Flash Grise	DLG31113	€ 212,00 *

PRIX TOTAL DU SET: 2.139,00 €

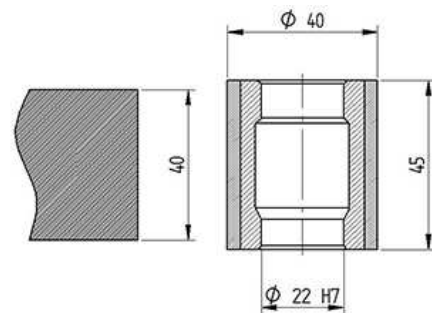

MEULE POUR INTÉRIEUR DE CUVE

Diamètre 20 mm – 1/2 GAS



Profils disponibles sur le catalogue



Profil ferme

SHAPE	SHAPE SPECIFICATION	SHAPE	SHAPE SPECIFICATION
	A A36 R5 Lower side A36 R5 Upper side		E E36 B8 Polish down E36 B8 Polish up E42 B4 Polish up
	T T23 R3 T33 R3 T32 R6		X X20 18x22 X30 26x33 X30 23x33
	Z Z45		

Parametres de travail:

POS	D	H	TYPE ARTICLE	RPM	AVANCE mm/min	ENLEVEMENT mm
1	37,5	1/2 GAS	Couronne continue ebauche	5500-6000	800-1000	0,5 max
2	37,5	1/2 GAS	Couronne continue ebauche	5500-6000	800-1000	0,3
3	37,5	1/2 GAS	Couronne continue medium	5500-6000	800-1000	0,2
4	37,5	1/2 GAS	Couronne continue fine	5500-6000	700-900	0,1
5	37,5	1/2 GAS	Flash Bleu	2500-2800	800-1000	0,05
6	37,5	1/2 GAS	Flash Blanche	2500-2800	800-1000	0,05
7	37,5	1/2 GAS	Flash Grise	2500-2800	800-1000	0,05
5S	37,5	1/2 GAS	Couronne continue fine 5S	5500-6000	700-900	0,1

A36R5 inferieur

POS	D	ID	H	TYPE D'ARTICLE	CODE	PRIX	
1	37,5	21,5	1/2 GAS	Couronne continue ebauche	DGG79394	€ 240,00	*
2	37,5	21,5	1/2 GAS	Couronne continue ebauche	DGG79395	€ 240,00	*
3	37,5	21,5	1/2 GAS	Couronne continue medium	DGG79396	€ 240,00	*
4	37,5	21,5	1/2 GAS	Couronne continue fine	DGG80243	€ 240,00	*
5	37,5	21,5	1/2 GAS	Flash Bleu	DLG30115	€ 160,00	*
6	37,5	21,5	1/2 GAS	Flash Blanche	DLG30116	€ 160,00	*
7	37,5	21,5	1/2 GAS	Flash Grise	DLG30117	€ 160,00	*

PRIX TOTAL DU SET:1.440,00 €

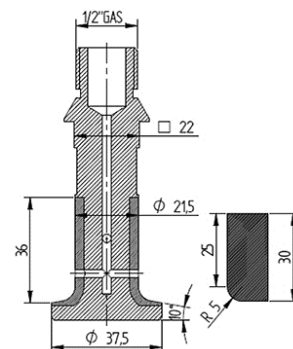

Extra fin

POS	D	ID	H	TYPE D'ARTICLE	CODE	PRIX	
5S	37,5	21,5	1/2 GAS	5S Couronne continue fine	DGG79397	€ 240,00	*

A35R5 superieur

POS	D	ID	H	TYPE D'ARTICLE	CODE	PRIX	
1	37,5	21,5	1/2 GAS	Couronne continue ebauche	DGG79993	€ 240,00	*
2	37,5	21,5	1/2 GAS	Couronne continue ebauche	DGG79994	€ 240,00	*
3	37,5	21,5	1/2 GAS	Couronne continue medium	DGG79995	€ 240,00	*
4	37,5	21,5	1/2 GAS	Couronne continue fine	DGG79996	€ 240,00	*
5	37	21	1/2 GAS	Flash Bleu	DLG30304	€ 160,00	*
6	37	21	1/2 GAS	Flash Blanche	DLG30305	€ 160,00	*
7	37	21	1/2 GAS	Flash Grise	DLG30306	€ 160,00	*

PRIX TOTAL DU SET:1.440,00 €

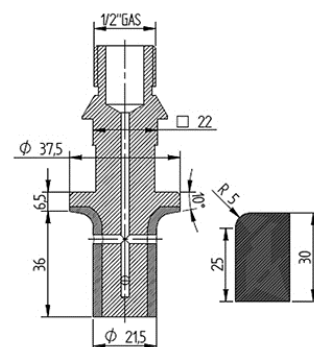

Extra fin

POS	D	ID	H	TYPE D'ARTICLE	CODE	PRIX	
5S	37,5	21,5	1/2 GAS	5S Couronne continue fine	DGG84076	€ 240,00	*

E36B8 inferieur

POS	D	ID	H	TYPE D'ARTICLE	CODE	PRIX	
1	37,5	21,5	1/2 GAS	Couronne continue ebauche	DGG80033	€ 240,00	*
2	37,5	21,5	1/2 GAS	Couronne continue ebauche	DGG80126	€ 240,00	*
3	37,5	21,5	1/2 GAS	Couronne continue medium	DGG80127	€ 240,00	*
4	37,5	21,5	1/2 GAS	Couronne continue fine	DGG80128	€ 240,00	*
5	37	21	1/2 GAS	Flash Bleu	DLG31093	€ 160,00	*
6	37	21	1/2 GAS	Flash Blanche	DLG31094	€ 160,00	*
7	37	21	1/2 GAS	Flash Grise	DLG31095	€ 160,00	*

PRIX TOTAL DU SET:1.440,00 €

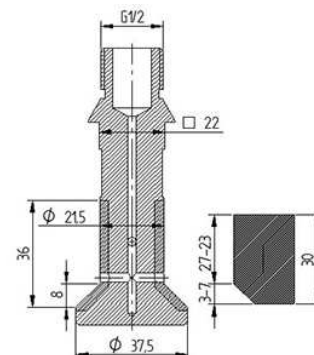

Extra fin

POS	D	ID	H	TYPE D'ARTICLE	CODE	PRIX	
5S	37,5	21,5	1/2 GAS	5S Couronne continue fine	DGG80000	€ 240,00	*

E36B8 superieur

POS	D	ID	H	TYPE D'ARTICLE	CODE	PRIX	
1	37,5	21,5	1/2 GAS	Couronne continue ebauche	DGG79997	€ 240,00	*
2	37,5	21,5	1/2 GAS	Couronne continue ebauche	DGG79998	€ 240,00	*
3	37,5	21,5	1/2 GAS	Couronne continue medium	DGG79999	€ 240,00	*
4	37,5	21,5	1/2 GAS	Couronne continue fine	DGG80378	€ 240,00	*
5	36	20	1/2 GAS	Flash Bleu	DLG31096	€ 160,00	*
6	36	20	1/2 GAS	Flash Blanche	DLG31097	€ 160,00	*
7	36	20	1/2 GAS	Flash Grise	DLG31098	€ 160,00	*

PRIX TOTAL DU SET:1.440,00 €

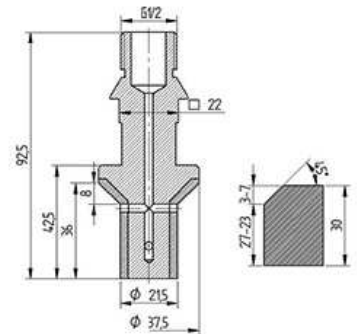

Extra fin

POS	D	ID	H	TYPE D'ARTICLE	CODE	PRIX	
5S	37,5	21,5	1/2 GAS	5S Couronne continue fine	DGG80129	€ 240,00	*

E42B4 inferieur

POS	D	ID	H	TYPE D'ARTICLE	CODE	PRIX	
1	29,5	21,5	1/2 GAS	Couronne continue ebauche	DGG83875	€ 240,00	*
2	29,5	21,5	1/2 GAS	Couronne continue ebauche	DGG83876	€ 240,00	*
3	29,5	21,5	1/2 GAS	Couronne continue medium	DGG83877	€ 240,00	*
4	29,5	21,5	1/2 GAS	Couronne continue fine	DGG83878	€ 240,00	*
5	29	21	1/2 GAS	Flash Bleu	DLG31633	€ 160,00	*
6	29	21	1/2 GAS	Flash Blanche	DLG31634	€ 160,00	*
7	29	21	1/2 GAS	Flash Grise	DLG31635	€ 160,00	*

PRIX TOTAL DU SET:1.440,00 €

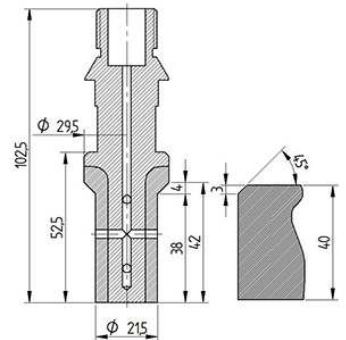

Extra fin

POS	D	ID	H	TYPE D'ARTICLE	CODE	PRIX	
5S	29,5	21,5	1/2 GAS	5S Couronne continue fine	DGG84064	€ 240,00	*

T23R3

POS	D	ID	H	TYPE D'ARTICLE	CODE	PRIX	
1	20	20	1/2 GAS	Couronne continue ebauche	DGG75373	€ 180,00	*
2	25	17,9	1/2 GAS	Couronne continue ebauche	DGG80297	€ 180,00	*
3	25	17,9	1/2 GAS	Couronne continue medium	DGG80298	€ 180,00	*
4	25	17,9	1/2 GAS	Couronne continue fine	DGG80299	€ 180,00	*
5	25	18	1/2 GAS	Flash Bleu	DLG30106	€ 150,00	*
6	25	18	1/2 GAS	Flash Blanche	DLG30107	€ 150,00	*
7	25	18	1/2 GAS	Flash Grise	DLG30108	€ 150,00	*

PRIX TOTAL DU SET:1.170,00 €

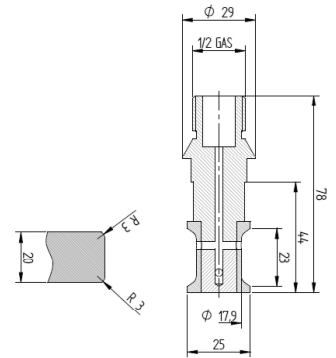

Extra fin

POS	D	ID	H	TYPE D'ARTICLE	CODE	PRIX	
5S	25	17,9	1/2 GAS	5S Couronne continue fine	DGG84065	€ 180,00	*

T33R3

POS	D	ID	H	TYPE D'ARTICLE	CODE	PRIX	
1	20	20	1/2 GAS	Couronne continue ebauche	DGG75373	€ 180,00	*
2	25	17,9	1/2 GAS	Couronne continue ebauche	DGG77531	€ 240,00	*
3	25	17,9	1/2 GAS	Couronne continue medium	DGG77532	€ 240,00	*
4	25	17,9	1/2 GAS	Couronne continue fine	DGG75459	€ 240,00	*
5	25	18	1/2 GAS	Flash Bleu	DLG30103	€ 160,00	*
6	25	18	1/2 GAS	Flash Blanche	DLG30104	€ 160,00	*
7	25	18	1/2 GAS	Flash Grise	DLG30105	€ 160,00	*

PRIX TOTAL DU SET:1.380,00 €

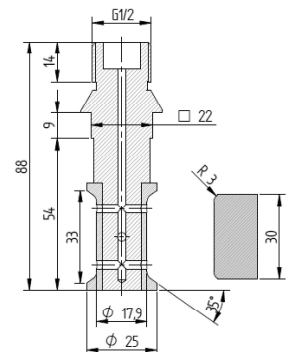

Extra fin

POS	D	ID	H	TYPE D'ARTICLE	CODE	PRIX	
5S	25	17,9	1/2 GAS	5S Couronne continue fine	DGG77533	€ 240,00	*

T32 R6

POS	D	ID	H	TYPE D'ARTICLE	CODE	PRIX
1	37	20,9	1/2 GAS	Couronne continue ebauche	DGG83313	€ 240,00 *
2	37	20,9	1/2 GAS	Couronne continue ebauche	DGG83314	€ 240,00 *
3	37	20,9	1/2 GAS	Couronne continue ebauche	DGG83315	€ 240,00 *
4	37	20,9	1/2 GAS	Couronne continue fine	DGG83316	€ 240,00 *
5	37	20,9	1/2 GAS	Flash Bleu	DLG31315	€ 160,00 *
6	37	20,9	1/2 GAS	Flash Blanche	DLG31316	€ 160,00 *
7	37	20,9	1/2 GAS	Flash Grise	DLG31317	€ 160,00 *

PRIX TOTAL DU SET:1.440,00 €

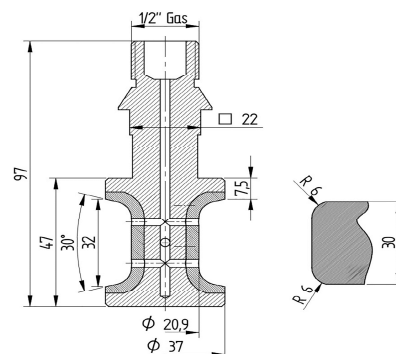

Extra fin

POS	D	ID	H	TYPE D'ARTICLE	CODE	PRIX
5S	37	20,9	1/2 GAS	5S Couronne continue fine	DGG84068	€ 240,00 *

X20 18X22

POS	D	ID	H	TYPE D'ARTICLE	CODE	PRIX
1	25	21	1/2 GAS	Couronne continue ebauche	DGG81512	€ 180,00 *
2	25	21	1/2 GAS	Couronne continue ebauche	DGG81513	€ 180,00 *
3	25	21	1/2 GAS	Couronne continue medium	DGG81514	€ 180,00 *
4	25	21	1/2 GAS	Couronne continue fine	DGG81515	€ 180,00 *
5	25	21	1/2 GAS	Flash Bleu	DLG30382	€ 150,00 *
6	25	21	1/2 GAS	Flash Blanche	DLG30383	€ 150,00 *
7	25	21	1/2 GAS	Flash Grise	DLG30384	€ 150,00 *

PRIX TOTAL DU SET:1.170,00 €

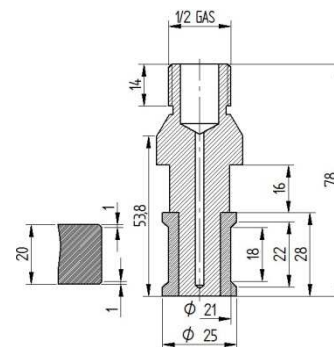

Extra fin

POS	D	ID	H	TYPE D'ARTICLE	CODE	PRIX
5S	25	21	1/2 GAS	5S Couronne continue fine	DGG84066	€ 180,00 *

X30 26X33

POS	D	ID	H	TYPE D'ARTICLE	CODE	PRIX
1	20	20	1/2 GAS	Couronne continue ebauche	DGG75373	€ 180,00 *
2	25	18	1/2 GAS	Couronne continue ebauche	DGG80519	€ 240,00 *
3	25	18	1/2 GAS	Couronne continue medium	DGG80520	€ 240,00 *
4	25	18	1/2 GAS	Couronne continue fine	DGG80521	€ 240,00 *
5	25	18	1/2 GAS	Flash Bleu	DLG30595	€ 160,00 *
6	25	18	1/2 GAS	Flash Blanche	DLG30596	€ 160,00 *
7	25	18	1/2 GAS	Flash Grise	DLG30597	€ 160,00 *

PRIX TOTAL DU SET:1.380,00 €

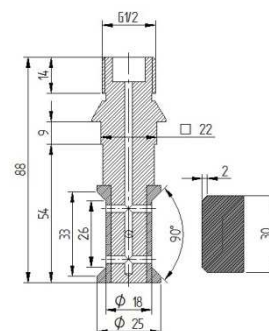

Extra fin

POS	D	ID	H	TYPE D'ARTICLE	CODE	PRIX
5S	25	18	1/2 GAS	5S Couronne continue fine	DGG84069	€ 240,00 *

X30 23x33

POS	D	ID	H	TYPE D'ARTICLE	CODE	PRIX	
1	30	20	1/2 GAS	Couronne continue ebauche	DGG82929	€ 240,00	*
2	30	20	1/2 GAS	Couronne continue ebauche	DGG82930	€ 240,00	*
3	30	20	1/2 GAS	Couronne continue medium	DGG82931	€ 240,00	*
4	30	20	1/2 GAS	Couronne continue fine	DGG82932	€ 240,00	*
5	29	19	1/2 GAS	Flash Bleu	DLG30941	€ 160,00	*
6	29	19	1/2 GAS	Flash Blanche	DLG30942	€ 160,00	*
7	29	19	1/2 GAS	Flash Grise	DLG30943	€ 160,00	*

PRIX TOTAL DU SET:1.440,00 €

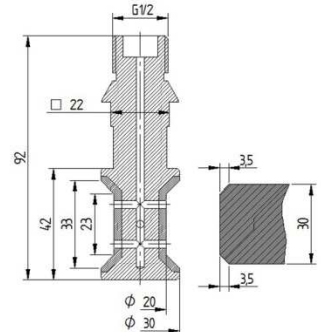

Extra fin

POS	D	ID	H	TYPE D'ARTICLE	CODE	PRIX	
5S	30	20	1/2 GAS	5S Couronne continue fine	DGG84067	€ 240,00	*

Z45

POS	D	ID	H	TYPE D'ARTICLE	CODE	PRIX	
1	20	20	1/2 GAS	Couronne continue ebauche	DGG75373	€ 180,00	*
2	20	20	1/2 GAS	Couronne continue ebauche	DGG75374	€ 180,00	*
3	20	20	1/2 GAS	Couronne continue medium	DGG75375	€ 180,00	*
4	20	20	1/2 GAS	Couronne continue fine	DGG75376	€ 180,00	*
5	20	20	1/2 GAS	Flash Bleu	DLG30292	€ 150,00	*
6	20	20	1/2 GAS	Flash Blanche	DLG30293	€ 150,00	*
7	20	20	1/2 GAS	Flash Grise	DLG30294	€ 150,00	*

PRIX TOTAL DU SET:1.170,00 €

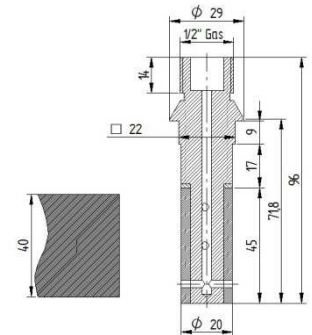

Extra fin

POS	D	ID	H	TYPE D'ARTICLE	CODE	PRIX	
5S	29	20	1/2 GAS	5S Couronne continue fine	DGG80116	€ 180,00	*

SMOAUTRE

Position extra enlèvement lignes

TYPE D'ARTICLE	D	T	H	CODE	PRIX
Resine	80	45	22	DGS83534	€ 268,00
Resine	20	45	1/2 GAS	DGS84015	€ 145,00

À utiliser avant les polissantes

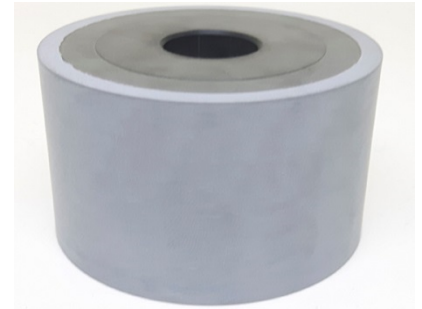

MEULE PÉRIPHÉRIQUE POUR MARBRE

Gamme meules électrodéposée
et polissante pour marbre

Set standard

POS.1	POS.2	POS.3	POS.4
1C	2L	3P	
ELECTRODEPOT	ELECTRODEPOT	ELECTRODEPOT	ABRASIVA



Set haute qualite

POS.3	POS.4	POS.5	POS.6
DIAMANT FINE	POLISSANTE BLEU	POLISSANTE BLANCHE	POLISSANTE GRISE







Diameter 120 mm

Profils disponibles sur le catalogue

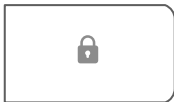

Profil ferme

SHAPE	SHAPE SPECIFICATION	SHAPE	SHAPE SPECIFICATION
	A A33 R15		B B23 R20 B33 R30
	F F33		T T23 R3
	V V22		

Parametres de travail:

Standard set

POS	D	RPM	AVANCE mm/min	ENLEVEMENT mm	POUSSÉE ADAPTATIVE
1	120	7000-8000	6000-8000	2	
2	120	7000-8000	8000-10000	0,5	
3	120	7000-8000	8000-10000	0,1	
4	120	1500	800-1200		3-5

Set haute qualite

POS	D	RPM	AVANCE mm/min	ENLEVEMENT mm
1	120	7000-8000	6000-8000	2
2	120	7000-8000	8000-10000	0,5
3	120	5500	800-1500	0,1-0,05
4	100	2700	1000-1500	0,05
5	100	2700	1000-1500	0,05
6	100	2700	1000-1500	0,05

A33

POS	D	ID	H	TYPE D'ARTICLE	CODE	PRIX
1	120	92	35	Electrodepot ebauche	DM00300	€ 489,00
2	120	92	35	Electrodepot medium	DM00301	€ 400,00
3	120	92	35	Electrodepot fin	DM01158	€ 400,00
4	120	92	35	Polissante	DLG10236	€ 178,00

PRIX TOTAL DU SET:1.467,00 €

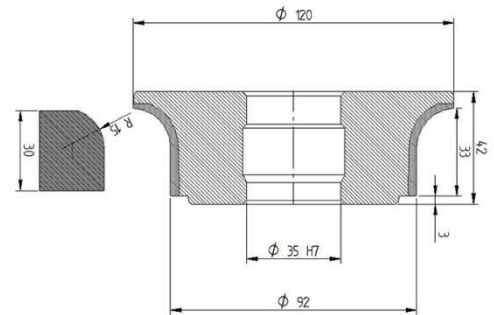

Set haute qualite

POS	D	ID	H	TYPE D'ARTICLE	CODE	PRIX
1	120	92	35	Electrodepot ebauche	DM00300	€ 489,00
2	120	92	35	Electrodepot medium	DM00301	€ 400,00
3	120	92	35	Couronne continue fine	DGS71519	€ 496,00
4	80	52	35	Flash Bleu	DLG30346	€ 194,00 *
5	80	52	35	Flash Blanche	DLG30347	€ 194,00 *
6	80	52	35	Flash Grise	DLG30348	€ 194,00 *

B23

POS	D	ID	H	TYPE D'ARTICLE	CODE	PRIX
1	120	74,8	35	Electrodepot ebauche	DM00342	€ 435,00
2	120	74,8	35	Electrodepot medium	DM00343	€ 363,00
3	120	74,8	35	Electrodepot fin	DM01160	€ 357,00
4	120	74,8	35	Polissante	DLG10237	€ 178,00

PRIX TOTAL DU SET:1.333,00 €

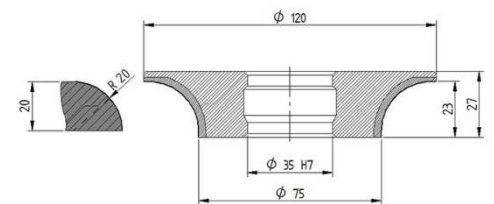

Set haute qualite

POS	D	ID	H	TYPE D'ARTICLE	CODE	PRIX
1	120	74,8	35	Electrodepot ebauche	DM00342	€ 435,00
2	120	74,8	35	Electrodepot medium	DM00343	€ 363,00
3	120	75	35	Couronne continue fine	DGS70837	€ 473,00
4	105	60	35	Flash Bleu	DLG30298	€ 228,00 *
5	105	60	35	Flash Blanche	DLG30299	€ 228,00 *
6	105	60	35	Flash Grise	DLG30300	€ 228,00 *

B33

POS	D	ID	H	TYPE D'ARTICLE	CODE	PRIX
1	120	57,4	35	Electrodepot ebauche	DM00286	€ 489,00
2	120	57,4	35	Electrodepot medium	DM00287	€ 377,00
3	120	57,4	35	Electrodepot fin	DM01161	€ 377,00
4	120	57,4	35	Polissante	DLG10150	€ 178,00

PRIX TOTAL DU SET:1.421,00 €

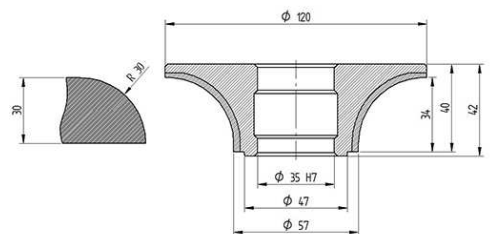

Set haute qualite

POS	D	ID	H	TYPE D'ARTICLE	CODE	PRIX
1	120	57,4	35	Electrodepot ebauche	DM00286	€ 489,00
2	120	57,4	35	Electrodepot medium	DM00287	€ 377,00
3	120	57	35	Couronne continue fine	DGS72732	€ 530,00
4	120	60	35	Flash Bleu	DLG30112	€ 228,00 *
5	120	60	35	Flash Blanche	DLG30113	€ 228,00 *
6	120	60	35	Flash Grise	DLG30114	€ 228,00 *

F33

POS	D	ID	H	TYPE D'ARTICLE	CODE	PRIX
1	120	58	35	Electrodepot ebauche	DM00364	€ 609,00
2	120	58	35	Electrodepot medium	DM00365	€ 464,00
3	120	58	35	Electrodepot fin	DM01164	€ 464,00
4	120	58	35	Polissante	DLG10291	€ 178,00

PRIX TOTAL DU SET:1.715,00 €

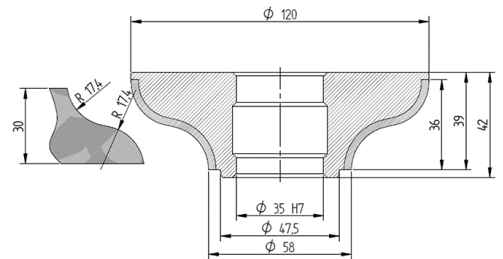

Set haute qualite

POS	D	ID	H	TYPE D'ARTICLE	CODE	PRIX
1	120	58	35	Electrodepot ebauche	DM00364	€ 609,00
2	120	58	35	Electrodepot medium	DM00365	€ 464,00
3	120	58	35	Couronne continue fine	DGS70900	€ 552,00
4	122	60	35	Flash Bleu	DLG30019	€ 228,00 *
5	122	60	35	Flash Blanche	DLG30020	€ 228,00 *
6	122	60	35	Flash Grise	DLG30021	€ 228,00 *

T23 R3

POS	D	ID	H	TYPE D'ARTICLE	CODE	PRIX
1	120	113	35	Electrodepot ebauche	DM00384	€ 406,00
2	120	113	35	Electrodepot medium	DM00385	€ 348,00
3	120	113	35	Electrodepot fin	DM01168	€ 348,00
4	120	113	35	Polissante	DLG10254	€ 178,00

PRIX TOTAL DU SET:1.280,00 €

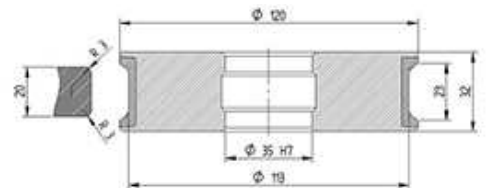

Set haute qualite

POS	D	ID	H	TYPE D'ARTICLE	CODE	PRIX
1	120	113	35	Electrodepot ebauche	DM00384	€ 406,00
2	120	113	35	Electrodepot medium	DM00385	€ 348,00
3	120	113	35	Couronne continue fine	DGS70861	€ 485,00
4	67	60	35	Flash Bleu	DLG30006	€ 172,00 *
5	67	60	35	Flash Blanche	DLG30007	€ 172,00 *
6	67	60	35	Flash Grise	DLG30008	€ 172,00 *

V22

POS	D	ID	H	TYPE D'ARTICLE	CODE	PRIX
1	120	96,5	35	Electrodepot ebauche	DM00402	€ 508,00
2	120	96,5	35	Electrodepot medium	DM00403	€ 415,00
3	120	96,5	35	Electrodepot fin	DM01172	€ 415,00
4	120	96,5	35	Polissante	DLG10259	€ 178,00

PRIX TOTAL DU SET:1.516,00 €

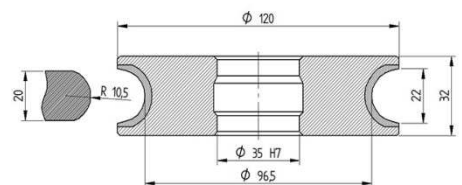

Set haute qualite

POS	D	ID	H	TYPE D'ARTICLE	CODE	PRIX
1	120	96,5	35	Electrodepot ebauche	DM00402	€ 508,00
2	120	96,5	35	Electrodepot medium	DM00403	€ 415,00
3	120	96	35	Couronne continue fine	DGS70855	€ 542,00
4	84	60	35	Flash Bleu	DLG30340	€ 196,00 *
5	84	60	35	Flash Blanche	DLG30341	€ 196,00 *
6	84	60	35	Flash Grise	DLG30342	€ 196,00 *

DIAMUT GRINDER



Le Grinder Diamut est une machine pour la rectification des profils de toutes les meules diamant utiliser dans le façonnage du verre et de la pierre. La machine est dotée de deux moteurs électrique : un pour faire tourner la meule qui est tenu par un cône ISO 40 et l'autre moteur qui fait tourner la meule de rectification pour reprofiler la meule diamant.

La meule est composé de carborundum et est montée sur un banc oscillant à quatres axes qui permet de corriger et rectifier à la perfection avec précision les formes les plus complexes.

tout les outils retrouve leur profil initial en peu de temps. le display électronique garantit une fine précision et des

temps de rectification très court à bas coûts. Le Grinder à aussi une otion de caméra digitale pour capturer l'image du profil et garantir le profil à 100%.



Disponible sur demande les disques pour rectifier chaque type de meule.

RETTIFICA UTENSILI

Diamut met à disposition sa professionnalité et sa précision pour effectuer un service de rectification pour chaque type d'outils. vsible sur le site web pour plus d'informations [DIAMUT,COM](http://DIAMUT.COM)



CHANT DROIT

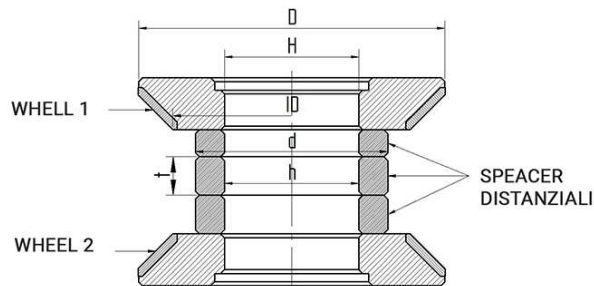

Meule diamant pour chanfreins

D	ID	H	RPM	AVANCE mm/min	ENLEVEMENT mm	CODE	PRIX
120	102	35	5500	1800-3000	0,2	DGS70572	€ 326,00
80	61	35	6000	1800-2500	0,2	DGS70825	€ 284,00
80	61	22	6000	1800-2500	0,2	DGS70570	€ 284,00
60	41	22	6000	1000-1500	0,2	DGS74611	€ 193,00



Deux pièces nécessaire par code

Entretoise pour meules chanfreins

d	h	t	CODE	PRIX
65	35	5	DD70018	€ 10,00
65	35	7	DD70019	€ 10,00
65	35	10	DD70031	€ 10,00
50	35	7+10+10	DD70000	€ 20,00
50	35	7	DD70013	€ 5,00
50	35	10	DD70014	€ 7,00
35	22	7+10+10	DD70002	€ 20,00
35	22	7	DD70074	€ 7,00
35	22	10	DD70075	€ 7,00



Support pour montage opposee

H	ALESAGE	L1	CODE	PRIX
35	22	50	DD70043	€ 110,00
35	22	85	DD70035	€ 110,00
35	22	100	DD70045	€ 80,00

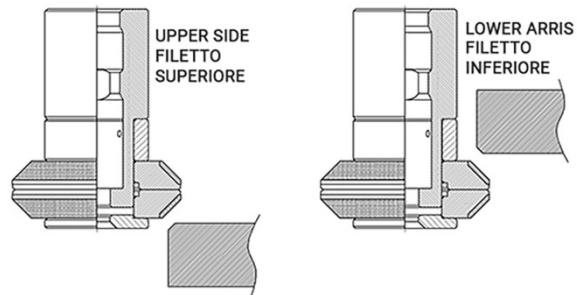

PLAN DU TRAVAIL

Sequenza di lavorazione

PIANO RIBASSATO

SVUOTATURA



POS. 1-2

FINITURA DEL PIANO
E DEL BORDO

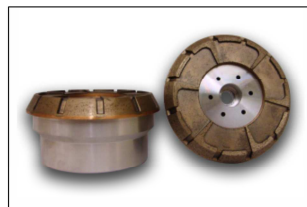

POS. 3-4

SOLO PER GRANITO
E MATERIALI SINTETICI

LUCIDATURA
DEL BORDO

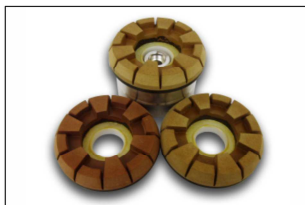

POS. 5-6-7

SOLO PER
GRANITO

LUCIDATURA
DEL PIANO



POS. 8-9-10-11



POS. 5-6-7



POS. 8-9-10-11

BRILLANTATURA
DEL PIANO
(SOLO GRANITO)

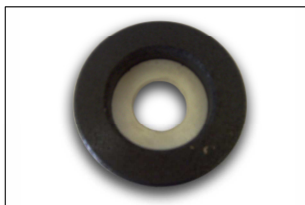

POS. 12

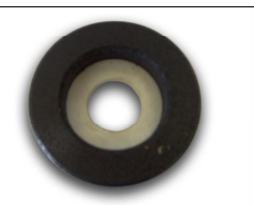

POS. 12

Set universel pour granit materil synthétique avec angle 60°

Set complet avec support

POS	TYPE D'ARTICLE	D	H	GRAIN	CODE	PRIX
1-2	Gros secteur	85	35	D427	DRI70162	€ 286,00
3	Couronne continue ebauche	120	35	D252	DRI70000	€ 445,00
4	Couronne continue fine	120	35	D64	DRI70001	€ 445,00
5	Arris Resine wheel	110	22	500	DRI70594	€ 265,00
6	Arris Resine wheel	110	22	1000	DRI70597	€ 265,00
7	Arris Resine wheel	110	22	2000	DRI70599	€ 265,00
8	Surface Resine wheel	100	22	500	DRI70595	€ 230,00
9	Surface Resine wheel	100	22	1000	DRI70596	€ 230,00
10	Surface Resine wheel	100	22	2000	DRI70598	€ 230,00
11	Surface Resine wheel	100	22	3000	DRI70600	€ 230,00
12	Buffer	100	22	BUFF	DRI70007	€ 254,00

CODE	RPM	AVANCE mm/min	AUGMENTATION DE L'AXE Z	POLISSAGE ÉPICYCLOÏDAL	PROFILAGE	VIDAGE	POUSSÉE ADAPTATIVE
DRI70162	3800-4200	600-1000	3,85			Yes	
DRI70000	3500	1000	3,95			Yes	
DRI70001	3500	1000	4			Yes	
DRI70594	800	2000	4		Yes		4-5
DRI70597	800	2000	4		Yes		4-5
DRI70599	800	2000	4		Yes		4-5
DRI70595	800	2500-4000	4	Yes		Yes	4-5
DRI70596	800	2500-5000	4	Yes			4-5
DRI70598	800	2500-5000	4	Yes			4-5
DRI70600	800	2000-5000	4	Yes			4-5
DRI70007	800	2000-5000	4	Yes			4-5

Rechange meule



POS	TYPE D'ARTICLE	D	H	GRAIN	CODE	PRIX
1-2	Gros secteur	85	50	D427	DRI70348	€ 255,00
5	Arris Resine wheel	110	@	500	DRI70543	€ 212,00
6	Arris Resine wheel	110	@	1000	DRI70544	€ 212,00
7	Arris Resine wheel	110	@	2000	DRI70545	€ 212,00
8	Surface Resine wheel	100	@	500	DRI70539	€ 177,00
9	Surface Resine wheel	100	@	1000	DRI70540	€ 177,00
10	Surface Resine wheel	100	@	2000	DRI70541	€ 177,00
11	Surface Resine wheel	100	@	3000	DRI70542	€ 177,00
12	Buffer	100	@	BUFF	DRI70111	€ 201,00

CODE	RPM	AVANCE mm/min	AUGMENTATION DE L'AXE Z	POLISSAGE ÉPICYCLOÏDAL	PROFILAGE	VIDAGE	POUSSÉE ADAPTATIVE
DRI70348	3800-4200	600-1000	3,85			Yes	
DRI70543	800	2000	4		Yes		4-5
DRI70544	800	2000	4		Yes		4-5
DRI70545	800	2000	4		Yes		4-5
DRI70539	800	2500-4000	4	Yes		Yes	4-7
DRI70540	800	2500-5000	4	Yes			4-7
DRI70541	800	2500-5000	4	Yes			4-7
DRI70542	800	2500-5000	4	Yes			4-5
DRI70111	800	2000-5000	4	Yes			4-6

Rechange support

POS	H	ALESAGE	CODE	PRIX
1-2	35	50+3F	D9594	€ 100,00
5-11	22	@	D9067	€ 100,00
12	22	@	D9068	€ 100,00
5-11	35	@	D9841	€ 100,00
12	35	@	D9258	€ 100,00



Meule avec attache magnetique

POS	TYPE D'ARTICLE	D	H	GRAIN	RPM	AVANCE mm/min	CODE	PRIX
5	Arris Resine wheel	110	22	500	800	2000	DRI70584	€ 212,00
6	Arris Resine wheel	110	22	1000	800	2000	DRI70585	€ 212,00
7	Arris Resine wheel	110	22	2000	800	2000	DRI70586	€ 212,00
8	Surface Resine wheel	100	22	500	800	2500-4000	DRI70580	€ 138,00
9	Surface Resine wheel	100	22	1000	800	2500-5000	DRI70581	€ 138,00
10	Surface Resine wheel	100	22	2000	800	2500-5000	DRI70582	€ 138,00
11	Surface Resine wheel	100	22	3000	800	2000-2500	DRI70583	€ 138,00

Support meule attache magnetique

H	CODE	PRIX
1/2 GAS	D9824	€ 191,00

Set granit avec angle 60°

Set complet avec support

POS	TYPE D'ARTICLE	D	H	GRAIN	CODE	PRIX
1-2	Gros secteur	85	35	D427	DRI70162	€ 286,00
3	Couronne continue ebauche	120	35	D252	DRI70000	€ 445,00
4	Couronne continue fine	120	35	D64	DRI70001	€ 445,00
5	Arris Resine wheel	125	35	400	DRI70002	€ 297,00
6	Arris Resine wheel	125	35	800	DRI70008	€ 297,00
7	Arris Resine wheel	125	35	1500	DRI70009	€ 297,00
8	Surface Resine wheel	100	22	500	DRI70011	€ 186,00
9	Surface Resine wheel	100	22	1000	DRI70012	€ 186,00
10	Surface Resine wheel	100	22	2000	DRI70013	€ 186,00
11	Surface Resine wheel	100	22	3000	DRI70014	€ 186,00
12	Buffer	100	22	BUFF	DRI70007	€ 254,00

CODE	RPM	AVANCE mm/min	AUGMENTATION DE L'AXE Z	POLISSAGE ÉPICYCLOÏDAL	PROFILAGE	VIDAGE	POUSSÉE ADAPTATIVE
DRI70162	3800-4200	600-1000	3,85			Yes	
DRI70000	3500	1000	3,95			Yes	
DRI70001	3500	1000	4			Yes	
DRI70002	800	2000	4		Yes		
DRI70008	800	2000	4		Yes		
DRI70009	800	2000	4		Yes		
DRI70011	800	4000	4	Yes		Yes	4-5
DRI70012	800	5000	4	Yes			4-5
DRI70013	800	5000	4	Yes			4-5
DRI70014	800	2500-5000	4	Yes			4-5
DRI70007	800	2000-5000	4	Yes			4-5

Rechange meule



Pos. 1-2

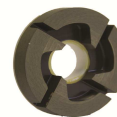

Pos. 8-9-10-11



Pos. 12

POS	TYPE D'ARTICLE	D	H	GRAIN	CODE	PRIX
1-2	Gros secteur	85	50	D427	DRI70348	€ 255,00
8	Surface Resine wheel	100	@	500	DRI70096	€ 138,00
9	Surface Resine wheel	100	@	1000	DRI70097	€ 138,00
10	Surface Resine wheel	100	@	2000	DRI70098	€ 138,00
11	Surface Resine wheel	100	@	3000	DRI70099	€ 138,00
12	Buffer	100	@	BUFF	DRI70111	€ 201,00

CODE	RPM	AVANCE mm/min	AUGMENTATION DE L'AXE Z	POLISSAGE ÉPICYCLOÏDAL	PROFILAGE	VIDAGE	POUSSÉE ADAPTATIVE
DRI70348	3800-4200	600-1000	3,85			Yes	
DRI70096	1600	10000	4	Yes		Yes	4-5
DRI70097	1600	10000	4	Yes			4-5
DRI70098	1600	10000	4	Yes			4-5
DRI70099	1600	10000	4	Yes			4-5
DRI70111	800	2000-5000	4	Yes			4-6

Recharge support

POS	H	ALESAGE	CODE	PRIX
1-2	35	50+3F	D9594	€ 100,00
5-11	22	@	D9067	€ 100,00
12	22	@	D9068	€ 100,00
5-11	35	@	D9841	€ 100,00
12	35	@	D9258	€ 100,00



RAINURES

Fraise pour rainures cannelures 10mm attache 1/2" gas

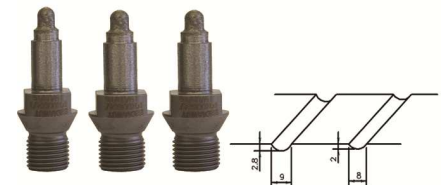

POS	D	R	H	GRAIN	RPM	AVANCE mm/min	ENLEVEMENT mm	CODE	PRIX
1	10	4,3	1/2 GAS	D252	6000-6500	400-500	A profilo / To profile	DFR00664	€ 106,00
2	10	4,8	1/2 GAS	D64	6000-6500	400-500	0,3 max	DFR00665	€ 106,00
3	10	5	1/2 GAS	D39	6000-6500	400-500	0-0,05	DFR00666	€ 106,00

Fraise pour rainures cannelures 12mm attache 1/2" gas

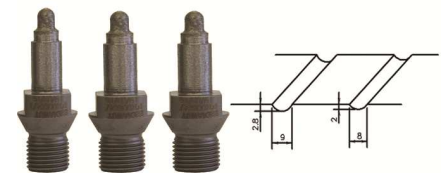

POS	D	R	H	GRAIN	RPM	AVANCE mm/min	ENLEVEMENT mm	CODE	PRIX
1	12	5,3	1/2 GAS	D252	6000-6500	400-500	A profilo / To profile	DFR00959	€ 106,00
2	12	5,8	1/2 GAS	D64	6000-6500	400-500	0,3 max	DFR00960	€ 106,00
3	12	6	1/2 GAS	D39	6000-6500	400-500	0-0,05	DFR00961	€ 106,00

Fraise pour rainures cannelures 14mm attache 1/2" gas

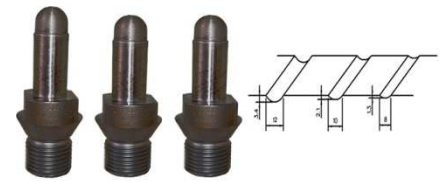

POS	D	R	H	GRAIN	RPM	AVANCE mm/min	ENLEVEMENT mm	CODE	PRIX
1	14	6,3	1/2 GAS	D252	6000-6500	400-500	A profilo / To profile	DFR00629	€ 106,00
2	14	6,8	1/2 GAS	D64	6000-6500	400-500	0,3 max	DFR00630	€ 106,00
3	14	7	1/2 GAS	D39	6000-6500	400-500	0-0,05	DFR00670	€ 106,00

Fraise pour rainures cannelures 20mm attache 1/2" gas

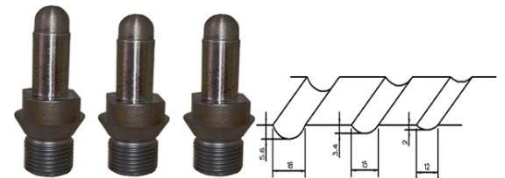

POS	D	R	H	GRAIN	RPM	AVANCE mm/min	ENLEVEMENT mm	CODE	PRIX
1	20	10	1/2 GAS	D252	6000-6500	400-500	A profilo / To profile	DFR07052	€ 127,00
2	20	10	1/2 GAS	D64	6000-6500	400-500	0,3 max	DFR07053	€ 127,00
3	20	10	1/2 GAS	D39	6000-6500	400-500	0-0,05	DFR07054	€ 127,00

Meules d'incisions pour rainures eggoutoirs diamètre 140mm - INTERMAC (1F1)



POS	D	TYPE D'ARTICLE	MATÉRIEL	H	T	R	GRAIN	RPM	AVANCE mm/min	CODE	PRIX
1	140	Couronne continue medium	ENG - HGR - SGR	30+1F	10	7	D76	2300-2400	500-1000	DI04196	€ 265,00
2	140	Polissante	HGR - SGR	30+1F	10	7	400	2000	500	DLG14648	€ 113,00
2	140	Polissante	ENG	30+1F	10	7	1000	2000	500	DLG16711	€ 117,00
1	140	Couronne continue medium	ENG - HGR - SGR	30+1F	15	10	D76	2300-2400	500-1000	DI04316	€ 350,00
2	140	Polissante	HGR - SGR	30+1F	15	10	400	2000	500	DLG15089	€ 113,00
2	140	Polissante	ENG	30+1F	15	10	1000	2000	500	DLG18451	€ 93,00

Utilisable pour agrégat attache magnétique

Meules d'incisions pour rainures eggoutoirs diamètre 150mm - BIMATECH (1F1)



POS	D	TYPE D'ARTICLE	MATÉRIEL	H	T	R	GRAIN	RPM	AVANCE mm/min	CODE	PRIX
1	150	Couronne continue medium	ENG - HGR - SGR	22+3F	10	7	D76	2300-2400	500-1000	DI04306	€ 265,00
2	140	Polissante	HGR - SGR	22+3F	10	7	400	2000	500	DLG14981	€ 113,00

Meules d'incisions pour rainures eggoutoirs diamètre 180mm - BIMATECH (1F1)



POS	D	TYPE D'ARTICLE	MATÉRIEL	H	T	R	GRAIN	RPM	AVANCE mm/min	CODE	PRIX
1	180	Couronne continue medium	ENG - HGR - SGR	22+3F	10	7	D76	2300-2400	500-1000	DI04307	€ 345,00
2	180	Polissante	HGR - SGR	22+3F	10	7	400	2000	500	DLG14996	€ 164,00

Incision V (Tile)

20 mm

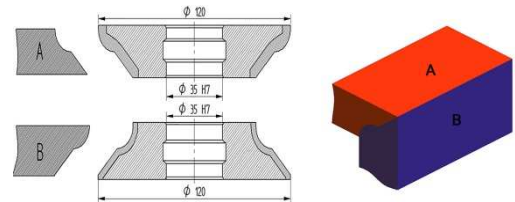

POS	TILE TYPE	D	H	TYPE D'ARTICLE	RPM	AVANCE mm/min	ENLEVEMENT mm	CODE	PRIX
1	A	120	35	Gros secteur	5500	2500-3000	2	DGS81921	€ 415,00
2	A	120	35	Medium segmented	6000	3000-4500	0,4	DGS81922	€ 455,00
1	B	120	35	Gros secteur	5500	2500-3000	2	DGS81923	€ 415,00
2	B	120	35	Medium segmented	6000	3000-4500	0,4	DGS81924	€ 455,00

30 mm

POS	TILE TYPE	D	H	TYPE D'ARTICLE	RPM	AVANCE mm/min	ENLEVEMENT mm	CODE	PRIX
1	A	120	35	Gros secteur	5500	2500-3000	2	DGS81941	€ 474,00
2	A	120	35	Medium segmented	6000	3000-4500	0,4	DGS81942	€ 513,00
1	B	120	35	Gros secteur	5500	2500-3000	2	DGS81943	€ 474,00
2	B	120	35	Medium segmented	6000	3000-4500	0,4	DGS81944	€ 513,00

Mitre 45

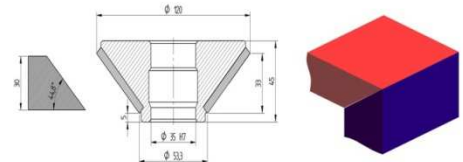

POS	D	H	TYPE D'ARTICLE	RPM	AVANCE mm/min	CODE	PRIX
1	120	35	Gros secteur	5000	1000-4000	DGS81335	€ 454,00
2	120	35	Medium segmented	5000	1000-4000	DGS81336	€ 454,00
3	120	35	Fine segmented	5000	1000-4000	DGS81879	€ 454,00

MEULE D'ÉBAUCHE

Meule d'ébauche pour gros enlèvement granit et synthétique



D	H	T	MATÉRIEL	GRAI N	RPM	AVANCE mm/min	ENLEVEMENT mm	CODE	PRIX
56	20	30	ENG - HGR - SGR	D602	4500-5000	200-500	4-6	DRI70643	€ 223,00
56	14	30	ENG - HGR - SGR	D602	4500-5000	200-500	4-6	DRI79275	€ 223,00
92	50	30	ENG - HGR - SGR	D602	4500-5000	200-500	4-6	DRI70605	€ 276,00
92	50+4F(BAVELLONI)	30	ENG - HGR - SGR	D602	4500-5000	200-500	4-6	DRI70649	€ 276,00
150	50	30	ENG - HGR - SGR	D602	3000-4500	200-500	4-6	DRI70644	€ 472,00

Meule d'ébauche secteur pour granit et synthétique

D	H	T	Z	MATÉRIEL	GRAIN	CODE	PRIX
40	8	20	7	ENG - HGR - SGR	D301	DRI70536	€ 191,00
40	8	30	7	ENG - HGR - SGR	D301	DRI70636	€ 223,00
50	20	20	12	ENG - HGR - SGR	D301	DRI70390	€ 223,00
50	20	30	12	ENG - HGR - SGR	D301	DRI70235	€ 223,00
85	50	20	20	ENG - HGR - SGR	D427	DRI70348	€ 255,00
85	50+4F(BAVELLONI)	20	20	ENG - HGR - SGR	D427	DRI70407	€ 255,00
85	50	20	14	ENG - HGR - SGR	D427	DRI70406	€ 223,00
85	50	30	20	ENG - HGR - SGR	D427	DRI70405	€ 307,00
150	50	20	37	ENG - HGR - SGR	D427	DRI70522	€ 371,00
150	50	20	35	ENG - HGR - SGR	D427	DRI70688	€ 410,00



Avec sur la partie supérieure et inférieure

CODE	RPM	AVANCE mm/min	ENLEVEMENT mm
DRI70536	4500-5000	500-700	2-3
DRI70636	4500-5000	500-700	2-3
DRI70390	4500-5000	500-700	2-3
DRI70235	4500-5000	500-700	2-3
DRI70348	3800-4200	600-1000	2-3
DRI70407	3800-4200	600-1000	2-3
DRI70406	3800-4200	600-1000	2-3
DRI70405	3800-4200	600-1000	2-3
DRI70522	3800-4200	600-1000	2-3
DRI70688	3800-4200	600-1000	2-3

Avec sur la partie supérieure et inférieure

Meule d'ébauche Viper pour granit et synthétique

D	H	T	Z	MATÉRIEL	GRAIN	CODE	PRIX
90	50	30	16	ENG - HGR - SGR	D427	DRI70434	€ 339,00
90	50+4F(BAVELLONI)	30	16	ENG - HGR - SGR	D427	DRI70504	€ 339,00



CODE	RPM	AVANCE mm/min	ENLEVEMENT mm
DRI70434	3800-4200	600-1200	2-3
DRI70504	3800-4200	600-1200	2-3

Meule d'ébauche secteur pour granit tendre et pierre abrasive

D	H	T	Z	MATÉRIEL	GRAIN	CODE	PRIX
85	50	20	20	ENG - SGR	D301	DRI70482	€ 254,00
85	50	20	20	ENG - SGR	D427	DRI70475	€ 255,00
150	50	20	35	ENG - SGR	D427	DRI70652	€ 371,00



CODE	RPM	AVANCE mm/min	ENLEVEMENT mm
DRI70482	4500	600	4,3 max
DRI70475	3800-4200	600-1000	2-3
DRI70652	3000-4500	600-1200	2-3

Meule d'ébauche pour gros enlèvement marbre



D	H	T	MATÉRIEL	GRAIN	RPM	AVANCE mm/min	ENLEVEMENT mm	CODE	PRIX
56	20	30	M	D427	4500-5000	200-500	4-6	DRI79272	€ 223,00
92	50	30	M	D427	4500-5000	200-500	4-6	DRI79271	€ 276,00

Meule d'ébauche electrodépot marbre



D	H	T	MATÉRIEL	GRAIN	RPM	AVANCE mm/min	ENLEVEMENT mm	CODE	PRIX
50	10	20	M	D602	4500-5500	400-600	2-4	DRI70227	€ 225,00
85	50	20	M	D602	4000-5000	500-700	2-4	DRI70055	€ 348,00
85	50	30	M	D602	4000-5000	500-700	2-4	DRI70494	€ 530,00
150	50	20	M	D602	3000-4500	600-1200	2-4	DRI70645	€ 767,00

Extensions pour meules a décaissé

Attache 1/2" gas

L	L1	ALESAGE	H	D MEULE	CODE	PRIX
75	50	1/2 GAS	8	40	D12759	€ 100,00
165	135	1/2 GAS	8	40	D11010	€ 100,00
59	44	1/2 GAS	10	50	D9684	€ 100,00
59	44	1/2 GAS	14+3F	56	D12893	€ 100,00
59	44	1/2 GAS	20	50-56	D9528	€ 100,00
55	40	1/2 GAS	50	85-90-92-150	D10576	€ 150,00
55	55	1/2 GAS	50/50+4F (BAV)	85-90-92-150	D9788	€ 100,00



Fixation de potence cône ISO 40

L	L1	ALESAGE	H	D MEULE	CODE	PRIX
149	127	50+6F ISO 40	8	40	D11011	€ 145,00
200	178	50+6F ISO 40	10	50	D10105	€ 145,00
200	178	50+6F ISO 40	20	50-56	D10028	€ 145,00
227	205	50+6F ISO 40	20	50-56	D10031	€ 145,00
120	120	50+6F ISO 40	50/50+4F	85-90-92-150-1/2 GAS	D9697	€ 260,00
135	135	50+6F ISO 40	50/50+4F	85-90-92-150-1/2 GAS	D10199	€ 260,00
150	150	50+6F ISO 40	50/50+4F	85-90-92-150-1/2 GAS	D6953	€ 260,00
250	250	50+6F ISO 40	50/50+4F	85-90-92-150-1/2 GAS	D12635	€ 400,00

Fixation de potence cône ISO 40 avec traitement anti corrosion

L	L1	ALESAGE	H	D MEULE	CODE	PRIX
100	100	50+6F ISO 40	50/50+4F	85-90-92-150-1/2 GAS	D9286	€ 400,00
170	170	50+6F ISO 40	50/50+4F	85-90-92-150-1/2 GAS	D9180	€ 400,00
200	200	50+6F ISO 40	50/50+4F	85-90-92-150-1/2 GAS	D9224	€ 400,00
225	225	50+6F ISO 40	50/50+4F	85-90-92-150-1/2 GAS	D9092	€ 400,00
300	300	50+6F ISO 40	50/50+4F	85-90-92-150-1/2 GAS	D10124	€ 600,00
400	400	50+6F ISO 40	50/50+4F	85-90-92-150-1/2 GAS	D10194	€ 600,00

Fixation de potence cône ISO 50 pour meule de diamètre avec attache fraise foret 1/2"

L	L1	ALESAGE	H	D MEULE	CODE	PRIX
150	150	50+6F ISO 50	50	85-90-92-150	D12104	€ 600,00
170	170	50+6F ISO 50	50	85-90-92-150	D12623	€ 600,00
200	200	50+6F ISO 50	50	85-90-92-150	D12115	€ 600,00
250	250	50+6F ISO 50	50	85-90-92-150	D12105	€ 600,00
300	300	50+6F ISO 50	50	85-90-92-150	D12044	€ 800,00
350	350	50+6F ISO 50	50	85-90-92-150	D12622	€ 800,00
430	430	50+6F ISO 50	50	85-90-92-150	D12045	€ 990,00
450	450	50+6F ISO 50	50	85-90-92-150	D12106	€ 990,00



OUTILS DE DESSIN

Pointe a dessin PCD



V	Y	D	L	MATÉRIEL	ROTATION DROIT / ROTATION GAUCHE	RPM	AVANCE mm/min	ENLEVEMENT mm	CODE	PRIX
30	10	10	55	M	DX	7000-8000	300-500	2-3	DFFR00776	€ 38,00
60	10	10	55	M	DX	7000-8000	300-500	2-3	DFFR00568	€ 34,00
90	10	10	55	M	DX	7000-8000	300-500	2-3	DFFR00606	€ 34,00

Outils de dessin en PCD



V	Y	D	L	MATÉRIEL	ROTATION DROIT / ROTATION GAUCHE	RPM	AVANCE mm/min	ENLEVEMENT mm	CODE	PRIX
35	10	10	63	HGR - SGR	DX	7000-8000	500	2	DFFR90192	€ 146,00
60	10	10	63	HGR - SGR	DX	7000-8000	500	2	DFFR90354	€ 141,00
70	10	10	63	HGR - SGR	DX	7000-8000	500	2	DFFR90061	€ 141,00
90	10	10	63	HGR - SGR	DX	7000-8000	500	2	DFFR90027	€ 141,00
105	10	10	63	HGR - SGR	DX	7000-8000	500	2	DFFR90237	€ 141,00
120	10	10	63	HGR - SGR	DX	7000-8000	500	2	DFFR00103	€ 146,00

Support

H	ALESAGE	CODE	PRIX
1/2 GAS	10	DFR00636	€ 99,00
1/2 GAS	6-8-10	DFFR00729	€ 290,00

Support attache 1/2 gas pour pointe d'écriture



DFFR00729

Outils de gravure en PCD

V	Y	D	L	MATÉRIEL	ROTATION DROIT / ROTATION GAUCHE	RPM	AVANCE mm/min	ENLEVEMENT mm	CODE	PRIX
70	10	10	55	HGR - SGR	SX	7000-8000	500	2	DFFR90728	€ 154,00
90	10	10	55	HGR - SGR	SX	7000-8000	500	2	DFFR90727	€ 154,00

Support

H	ALESAGE	CODE	PRIX
1/2 GAS	10	DFR02885	€ 90,00

Support attache 1/2" gas pour pointe d'écriture SX



OUTILS POUR INCISION ET ÉCRITURE

Pointe a gravure sur marbre - diamant électrodéposé

Conique



D	V	Y	L	L1	RPM	AVANCE mm/min	ENLEVEMENT mm	CODE	PRIX
5	14	6	60	15	7000-8000	300-500	2-3	DFFR00666	€ 19,00
9	14	6	60	36	7000-8000	300-500	2-3	DFFR00667	€ 55,00
10	30	6	60	20	7000-8000	300-500	2-3	DFFR90209	€ 20,00
6	60	6	60	5,2	7000-8000	300-500	2-3	DFFR00694	€ 19,00
10	60	6	60	8,5	7000-8000	300-500	2-3	DFFR00695	€ 21,00

Cylindrique

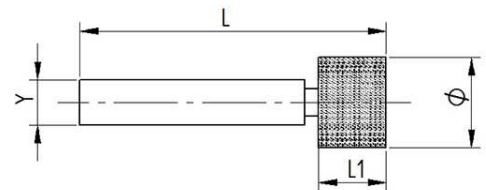

D	Y	L	L1	RPM	AVANCE mm/min	ENLEVEMENT mm	CODE	PRIX
3	6	60	12	7000-800	300-500	2-3	DFFR00023	€ 24,00
4	6	60	12	7000-8000	300-500	2-3	DFFR00713	€ 24,00
6	6	60	12	7000-8000	300-500	2-3	DFFR00692	€ 19,00
10	6	60	12	7000-8000	300-500	2-3	DFFR00693	€ 24,00

Sphérique



D	Y	L	RPM	AVANCE mm/min	ENLÈVEMENT mm	CODE	PRIX
6	6	60	7000-8000	300-500	2-3	DFFR00664	€ 19,00
10	6	60	7000-8000	300-500	2-3	DFFR00665	€ 23,00
16	6	60	7000-8000	300-500	2-3	DFFR00013	€ 38,00

Supports

H	ALESAGE	CODE	PRIX
1/2 GAS	6-8-10	DFFR00729	€ 290,00
1/2 GAS	6	DFR00590	€ 50,00

Support attache 1/2 gas pour pointe d'écriture



DFFR00729

Outils de gravure en PCD pour granit

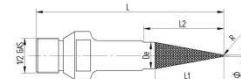

D	DE	R	L	L1	L2	RPM	AVANCE mm/min	ENLEVEMENT mm	CODICE	PRIX
8	11	4	110	15	60	8000-10000	500-700	5 max	DFFR90721	€ 512,00
5	8	2,5	110	15	60	8000-10000	500-700	2	DFFR90722	€ 457,00

Pointe a gravure conique PCD pour marbre tendre

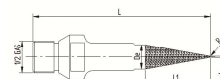

D	DE	R	L	L1	RPM	AVANCE mm/min	ENLEVEMENT mm	CODE	PRIX
11	20	5,5	72	40	8000-10000	500-700	5 max	DFFR00615	€ 249,00
6	18	3	68	28	8000-10000	500-700	2	DFFR00616	€ 165,00
5	12	2,5	64	50	8000-10000	500-700	2	DFFR90193	€ 270,00

Pointe a gravure conique PCD pour marbre dur

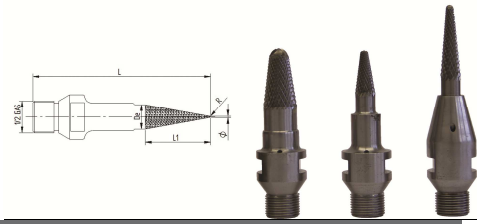

D	DE	R	L	L1	RPM	AVANCE mm/min	ENLEVEMENT mm	CODE	PRIX
11	20	5,5	72	40	8000-10000	500-700	5 max	DFFR00617	€ 253,00
6	18	3	68	28	8000-10000	500-700	2	DFFR00618	€ 163,00
5	12	2,5	64	50	8000-10000	500-700	2	DFFR90194	€ 289,00

Pointe a gravure conique PCD avec deux tranchants pour marbre

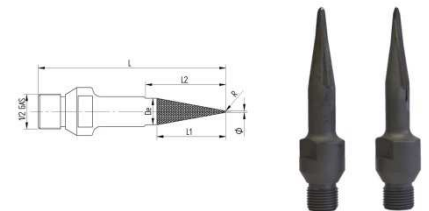

D	DE	R	L	L1	L2	RPM	AVANCE mm/min	ENLEVEMENT mm	CODICE	PRIX
8	24	4	130	50	80	8000-10000	800-1000	5 max	DFFR00004	€ 307,00
5	18	2,5	130	50	80	8000-10000	1500-2000	2	DFFR00003	€ 307,00
3	10	1,5	115	30	65	8000-10000	1000-1500	1	DFFR90718	€ 177,00
3	15	1,5	130	50	80	8000-10000	1000-1500	1	DFFR90019	€ 307,00
3	15	1,5	130	50	80	8000-10000	1000-1500	1	DFFR90726	€ 389,00
3	28	1,5	167	30	110	8000-10000	1000-1500	1	DFFR90724	€ 529,00

Pointe a gravure conique PCD spiralé pour marbre

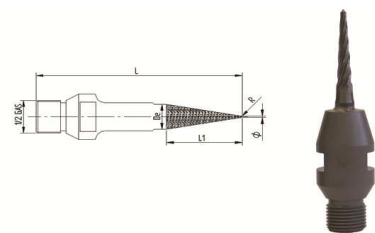

D	DE	R	L	L1	RPM	AVANCE mm/min	ENLEVEMENT mm	CODE	PRIX
5	12	2,5	50	50	8000-10000	500-700	2	DFFR90719	€ 279,00
3	10	1,5	50	50	8000-10000	500-700	1	DFFR90720	€ 279,00

OUTILS POUR BISEAUX



Boisseaux V0 - Intermac

POS	D	H	TYPE D'ARTICLE	GRAIN	RPM	AVANCE mm/min	ENLEVEMENT mm	POUSSÉE ADAPTATIVE	CODE	PRIX
1	150	22	Gros secteur	D427	3500	500-650	2,5max		DTB00066	€ 286,00
1	150	22	Gros secteur	D181	5000	700			DTB00099	€ 199,00
3	150	22	Resine	D91	3500	1000-1100	0,2		DTB00316	€ 244,00
4	150	22	Resine	D54	3500	1000	0,1		DTB00317	€ 244,00
5	150	22	Resine	600	3500	800	0,1		DTB00318	€ 244,00
6	150	22	Resine	800	3500	500	0,1		DTB00319	€ 244,00
7	150	22	Resine	1000	3500	500	0,1		DTB00320	€ 244,00
8	150	22	Resine	2000	3500	500	0,1		DTB00321	€ 244,00
9	150	22	Resine	3000	3500	500	0,05		DTB00322	€ 244,00
10	150	22	Buffer	BUFF	1200	500		3-8	DLG17638	€ 385,00

Pos.1 faire plusieurs passages pour gros enlèvement

Boisseaux V3 - Intermac

POS	D	H	TYPE D'ARTICLE	GRAIN	RPM	AVANCE mm/min	ENLEVEMENT mm	POUSSÉE ADAPTATIVE	CODE	PRIX
1	150	22	Gros secteur	D427	3500	500-650	2,5max		DTB00066	€ 286,00
1	150	22	Gros secteur	D181	5000	700			DTB00099	€ 199,00
3	150	22	Resine	D91	3500	1000-1100	0,2		DTB00332	€ 244,00
4	150	22	Resine	D54	3500	1000	0,1		DTB00333	€ 244,00
5	150	22	Resine	600	3500	800	0,1		DTB00334	€ 244,00
6	150	22	Resine	800	3500	500	0,1		DTB00335	€ 244,00
7	150	22	Resine	1000	3500	500	0,1		DTB00336	€ 244,00
8	150	22	Resine	2000	3500	500	0,1		DTB00337	€ 244,00
9	150	22	Resine	3000	3500	500	0,1		DTB00338	€ 244,00
10	150	22	Buffer	BUFF	1000-1500	500		10-15	DLG13993	€ 385,00

Pos.1 faire plusieurs passages pour gros enlèvement

Boisseaux V7 - diamètre 100 - Intermac

POS	D	H	TYPE D'ARTICLE	GRAIN	RPM	AVANCE mm/min	ENLEVEMENT mm	POUSSÉE ADAPTATIVE	CODE	PRIX
1	100	22+ 4F	Diamant	D427	5000	500-650	2max		DTB00198	€ 223,00
2	100	22+ 4F	Diamant	D181	5000	1200	0,35		DTB00199	€ 164,00
3	100	22+ 4F	Resine	D91	5000	800	0,2		DTB00309	€ 191,00
4	100	22+ 4F	Resine	D54	5000	800	0,1		DTB00310	€ 191,00
5	100	22+ 4F	Resine	600	5000	600	0,1		DTB00311	€ 191,00
6	100	22+ 4F	Resine	800	5000	500	0,1		DTB00312	€ 191,00
7	100	22+ 4F	Resine	1000	5000	500	0,1		DTB00313	€ 191,00
8	100	22+ 4F	Resine	2000	5000	500	0,1		DTB00314	€ 191,00
9	100	22+ 4F	Resine	3000	5000	500	0,05		DTB00315	€ 191,00
8	100	22	Surface Resine wheel	500	800	4000		4-5	DRI70011	€ 186,00

Pos.1 faire plusieurs passages pour gros enlèvement

Ébauche biseau 27°

POS	D	H	OUVERTURE DE LA GORGE	RPM	AVANCE mm/min	ENLEVEMENT mm	CODE	PRIX
1	150	35+M12	30	4000-5000	500-850	A profilo/ To profile	DGG83828	€ 640,00
2	150	35+M12	30	4000-5000	500-1000	1 max	DGG83829	€ 640,00



Pos.1 périphérique à utiliser à la place de la position 1 boisseaux

MEULE POUR FUNÉRAIR



Rouleau L170 - ISO40 Intermac

POS	TYPE D'ARTICLE	COULEUR	GRAIN	D	H	L	CODE	PRIX
1	Gros secteur	Nero	D427	80	ISO 40	180	DGS84088	€ 1.970,00
2	Gros secteur	Rosso	D64	80	ISO 40	180	DGS84089	€ 1.970,00
3	Couronne continue fine		D46	80	ISO 40	180	DGS84090	€ 2.990,00
4	Couronne continue fine		800	80	ISO 40	180	DGS84091	€ 2.990,00
5	Polissante		1000	80	ISO 40	170	DLG18467	€ 1.230,00
6	Polissante		2000	80	ISO 40	170	DLG18468	€ 1.230,00
7	Polissante		3000	80	ISO 40	170	DLG18469	€ 1.230,00
8	Buffer		BUFF	80	ISO 40	170	DLG18470	€ 1.230,00

CODE	RPM	AVANCE mm/min	ENLEVEMENT mm	POUSSÉE ADAPTATIVE	NOMBRE DE PAS
DGS84088	4000	550-600	0,45-0,6		1
DGS84089	4000	600	0,3		1
DGS84090	4000	800	0,075		1
DGS84091	3500	800	0-0,075		2
DLG18467	1200	500		3	1
DLG18468	1200	550		4	2
DLG18469	1200	650		4	1
DLG18470	1200	500		4	1

A utiliser avec oscillation

Pos.4 et 6 deuxième passage avec enlèvement 0mm e retour avec oscillation

Rechange meule

POS	TYPE D'ARTICLE	COULEUR	GRAIN	D	H	L	CODE	PRIX
1	Gros secteur	Black	D427	80	35	180	DGS83868	€ 1.330,00
2	Medium segmented	Rosso	D64	80	35	180	DGS83869	€ 1.330,00
3	Couronne continue fine		D46	80	35	180	DGS83953	€ 2.350,00
4	Couronne continue fine		800	80	35	180	DGS83870	€ 2.350,00
5	Polissante		1000	80	35	170	DLG18459	€ 590,00
6	Polissante		2000	80	35	170	DLG18460	€ 590,00
7	Polissante		3000	80	35	170	DLG18461	€ 590,00
8	Polissante		BUFF	80	35	170	DLG18462	€ 590,00

Supports

POS	SPINDLE	L1	ALESAGE	CODE	PRIX
1-8	ISO40	178	35	D12861	€ 650,00
1-8	ISO50	178	35	D12862	€ 850,00

Rouleau L65

POS	TYPE D'ARTICLE	COULEUR	GRAIN	D	H	L	CODE	PRIX
1	Gros secteur	Black	D427	80	35	65	DGS76012	€ 579,00
2	Couronne continue ebauche	Red	D126	80	35	65	DGS76013	€ 624,00
3	Couronne continue medium		D64	80	35	65	DGS76014	€ 624,00
4	Couronne continue fine		800	80	ISO40	65	DGS84087	€ 722,00
5	Polissante		1000	80	35	70	DLG18463	€ 455,00
6	Polissante		2000	80	35	70	DLG18464	€ 455,00
7	Polissante		3000	80	35	70	DLG18465	€ 455,00
8	Polissante		BUFF	80	35	70	DLG18466	€ 455,00

Pos. 4 ISO40 Intermac

Rechange meule

POS	TYPE D'ARTICLE	COULEUR	GRAIN	D	H	L	CODE	PRIX
4			800	80	35		DGG76015	€ 583,00

Supports

POS	SPINDLE	L1	ALESAGE	CODE	PRIX
A	ISO 40	47	35	P6390P0041	€ 94,00

OUTILS POUR USINAGE INTÉRIEUR DE CUVE

Pour granit avec cône de potence ISO 40

POS	D	R	L	L1	RPM	AVANCE mm/min	ENLEVEMENT mm	CODE	PRIX
1	50	20	160	50	4500-4800	600-1000	1-4	DLM70061	€ 449,00
2	50	20	160	50	4500-4800	600-1000	1-4	DLM70062	€ 625,00
1	80	25	225	50	4500-4800	600-1000	1-4	DLM70035	€ 650,00
2	80	25	225	50	4500-4800	600-1000	1-4	DLM70036	€ 530,00
3	80	25	225	50	4500-4800	600-1000	1-4	DLM70037	€ 530,00



Pour granit avec cône 1/2"

POS	D	R	L	L1	RPM	AVANCE mm/min	ENLEVEMENT mm	CODE	PRIX
1	85	20	90	50	4500-4800	600-1000	1-4	DLM70141	€ 244,00

Pour marbre - tête diamantée dépôt
electrolytique

POS	D	R	L	L1	RPM	AVANCE mm/min	ENLEVEMENT mm	CODE	PRIX
1	85	20	60	60	5000-6000	600-1000	1-4	DLM70018	€ 820,00
2	85	20	60	60	5000-6000	600-1000	1-4	DLM70019	€ 429,00
3	85	20	60	60	5000-6000	600-1000	1-4	DLM70020	€ 479,00

Rallonge iso40 pour tête dépôt electrolytique marbre avec traitement
niploy

L	L1	ALESAGE	H	D MEULE	CODE	PRIX
100	100	50+6F ISO 40	50/50+4F	85-90-92-150-1/2 GAS	D9286	€ 400,00
170	170	50+6F ISO 40	50/50+4F	85-90-92-150-1/2 GAS	D9180	€ 400,00
200	200	50+6F ISO 40	50/50+4F	85-90-92-150-1/2 GAS	D9224	€ 400,00
225	225	50+6F ISO 40	50/50+4F	85-90-92-150-1/2 GAS	D9092	€ 400,00
300	300	50+6F ISO 40	50/50+4F	85-90-92-150-1/2 GAS	D10124	€ 600,00
400	400	50+6F ISO 40	50/50+4F	85-90-92-150-1/2 GAS	D10194	€ 600,00

OUTILS POUR POLISSAGE DE LA SUPERFICIE - CNC

**Diamètre 250 mm pour surfaces
plates granit et matériaux
synthétiques**



TYPE D'ARTICLE	GRAIN	D	H	MATÉRIEL	RPM	AVANCE mm/min	ENLEVEMENT mm	CODE	PRIX
Gros secteur	D427	150	50	ENG - SGR	3000-4500	600-1200	2-3	DRI70652	€ 371,00

Support

H	CODE	PRIX
35	D9594	€ 100,00

Multi usage (granit et synthétique)

TYPE D'ARTICLE	GRAIN	D	H	MATÉRIEL	CODE	PRIX
Surface Resine wheel	200	100	@	ENG - HGR - SGR	DRI70554	€ 177,00
Surface Resine wheel	500	100	@	ENG - HGR - SGR	DRI70539	€ 177,00
Surface Resine wheel	1000	100	@	ENG - HGR - SGR	DRI70540	€ 177,00
Surface Resine wheel	2000	100	@	ENG - HGR - SGR	DRI70541	€ 177,00
Surface Resine wheel	3000	100	@	ENG - HGR - SGR	DRI70542	€ 177,00
Buffer	BUFF	100	@	HGR - SGR	DRI70111	€ 201,00



Pour 2/3/4/5/6/7 il est nécessaire 3 quantités, le prix indiqué est pour 1 pièce
Conseil utilisation epicycloidale

Seulement pour granit

TYPE D'ARTICLE	GRAIN	D	H	MATÉRIEL	CODE	PRIX
Surface Resine wheel	200	100	@	HGR - SGR	DRI70130	€ 138,00
Surface Resine wheel	500	100	@	HGR - SGR	DRI70096	€ 138,00
Surface Resine wheel	1000	100	@	HGR - SGR	DRI70097	€ 138,00
Surface Resine wheel	2000	100	@	HGR - SGR	DRI70098	€ 138,00
Surface Resine wheel	3000	100	@	HGR - SGR	DRI70099	€ 138,00
Buffer	BUFF	100	@	HGR - SGR	DRI70111	€ 201,00



Pour 2/3/4/5/6/7 il est nécessaire 3 quantités, le prix indiqué est pour 1 pièce

Support

H	CODE	PRIX
35	D12075	€ 200,00

OUTILS POUR POLISSAGE DE LA SUPERFICIE - CNC



Diamètre de 150 mm pour des surfaces inclinées amplitude maximale 150 mm - granit et matériaux synthétiques

POS	TYPE D'ARTICLE	GRAIN	D	H	RPM	AVANCE mm/min	POUSSÉE ADAPTATIVE	CODE	PRIX
1	Gros secteur	D602	92	50	4500-5000	200-500		DRI70605	€ 276,00
2	Resine	100	150	@	800-1000	4000-5000	5-7	DRI70681	€ 133,00
3	Resine	200	150	@	800-1000	4000-5000	5-7	DRI70682	€ 133,00
4	Resine	500	150	@	800-1000	4000-5000	5-7	DRI70683	€ 133,00
5	Resine	1000	150	@	800-1000	4000-5000	5-7	DRI70684	€ 133,00
6	Resine	2000	150	@	800-1000	4000-5000	5-7	DRI70685	€ 133,00
7	Resine	3000	150	@	800-1000	4000-5000	5-7	DRI70686	€ 133,00
8	Resine	BUFF	150	@	800-1000	4000-5000	5-7	DRI70687	€ 133,00

Pos 2-8 utiliser comme epicycloidale

Supports

POS	H	CODE	PRIX
Mat. inox -> Mola da scasso / stubbing wheel	35	D9594	€ 100,00
2-8	35	D9666	€ 100,00

OUTILS À VIEILLIR

Brosse à vieillir pour la superficie diamètre 130

POS	GRAIN	H	RPM	AVANCE mm/min	SÉQUENCE RECOMMANDÉE	CODE	PRIX
1	Metal	@	4000	1000	Yes	DLG16538	€ 160,00
2	46	@	4000	1000	Yes	DLG15000	€ 135,00
3	60	@	4000	1000		DLG15001	€ 135,00
4	80	@	4000	1000		DLG15002	€ 135,00
5	120	@	4000	1000	Yes	DLG15003	€ 135,00
6	240	@	4000	1000		DLG15004	€ 135,00
7	320	@	4000	1000	Yes	DLG15005	€ 135,00
8	500	@	4000	1000	Yes	DLG15006	€ 135,00



Support pour brosse

H	CODE	PRIX
35	D9666	€ 100,00



Brosse à vieillir pour la superficie diamètre 100

POS	GRAIN	H	RPM	AVANCE mm/min	SÉQUENCE RECOMMANDÉE	CODE	PRIX
1	Metal	@	4000	1000	Yes	DLG16537	€ 130,00
2	46	@	4000	1000	Yes	DLG15010	€ 95,00
3	60	@	4000	1000		DLG15011	€ 95,00
4	80	@	4000	1000		DLG15012	€ 95,00
5	120	@	4000	1000	Yes	DLG15013	€ 95,00
6	240	@	4000	1000		DLG15014	€ 95,00
7	320	@	4000	1000	Yes	DLG15015	€ 95,00
8	500	@	4000	1000	Yes	DLG15016	€ 95,00



Support pour brosse

H	CODE	PRIX
22	D9665	€ 60,00
35	D9755	€ 80,00



Brosse à vieillir le chant diamètre 150

POS	GRAIN	H	RPM	AVANCE mm/min	SÉQUENCE RECOMMANDÉE	CODE	PRIX
1	46	22	800	800	Yes	DLG15035	€ 145,00
2	120	22	800	800	Yes	DLG15036	€ 145,00
3	240	22	800	800		DLG15037	€ 145,00



OUTILS POUR POLISSAGE DES INTÉRIEURS DE CUVE SUR CNC

Pour agrégat Interamac



Granit et synthétique

POS	TYPE D'ARTICLE	GRAIN	D	H	CODE	PRIX
1	Gros secteur	D107	160	70	DRI70509	€ 382,00
2	Medium segmented	D76	160	70	DRI70566	€ 382,00
3	Polissante	500	150	@	DRI79218	€ 143,00
4	Polissante	1000	150	@	DRI79219	€ 143,00
5	Polissante	2000	150	@	DRI79220	€ 143,00
6	Polissante	3000	150	@	DRI79221	€ 143,00

CODE	RPM	AVANCE mm/min	ENLEVEMENT mm	POUSSÉE ADAPTATIVE	CONSOMMATION STATISTIQUE
DRI70509	3500-4000	600	0,7		
DRI70566	3500-4000	600	0,3		
DRI79218	800	600		5-7	50
DRI79219	800	600		5-7	50
DRI79220	800	600		5-7	50
DRI79221	800	600		5-7	50

DIAMANT POUR POLISSOIR À CHANT

Process polissoire à champs

MEULE PRÉDÉCOUPE



MEULE GÉNÉRATRICE



RAINURES



DISQUE



MEULE CALIBRAGE

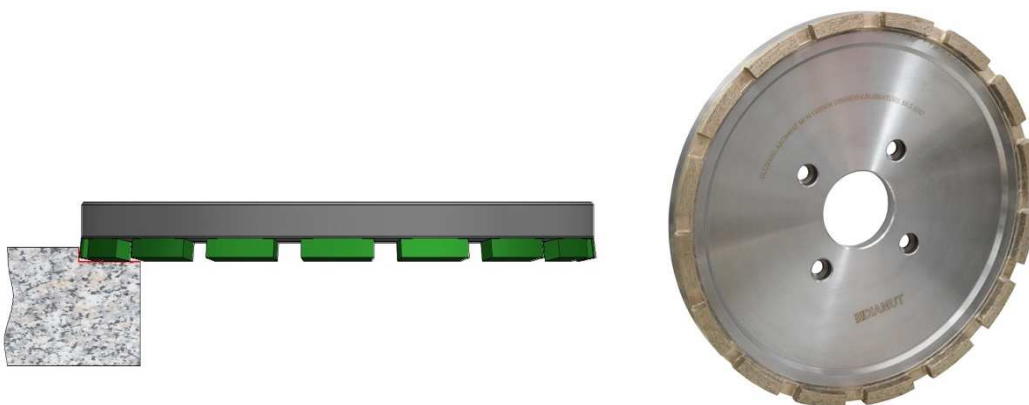

MEULE COMBINÉE



Comandulli

TYPE D'OUTIL	MACHINE	D	T	H	V	R	MATÉRIEL	CODE	PRIX
Calibrating Wheel	EDILUX - SYNTHESIS - OMEGA 60/100 - LUX LINE	260	18	50+4F			ENG - HGR - SGR	DLC00048	€ 350,00
Calibrating Wheel	MUSA - PENTA - SPIRA - OPTIMA - ALMA	190	27	50+4F			ENG - HGR - SGR	DLC00045	€ 297,00
Pre-Cutting Wheel	SYNTHESIS - OMEGA 60/100 - ALMA	155	45	50+4F	60		ENG - HGR - SGR	DLC00012	€ 377,00
Bevel cup wheel	EDILUX	100	47	M30	60		ENG - HGR - SGR	DLC00093	€ 340,00
Generating Wheel	SYNTHESIS - OMEGA 60/100 - ALMA	130	53	M30	60		ENG - HGR - SGR	DLC00013	€ 372,00
Generating Wheel	NEW SYSTEM 180 ATHENA SYSTEM PLUS	120	20	40+4F	90		ENG - HGR - SGR	DLC00043	€ 350,00
Generating Wheel	NEW SYSTEM 180 SPEEDY SYSTEM - ATHENA SYSTEM PLUS	150	20	40+4F		CONV. R10	ENG - HGR - SGR	DLC00063	€ 735,00
Generating Wheel	NEW SYSTEM 180 SPEEDY SYSTEM	120	44	M24	90		ENG - HGR - SGR	DLC00044	€ 350,00
Generating Wheel	SYSTEM 180	120	47	M18	90		ENG - HGR - SGR	DLC00032	€ 339,00
Drain Groove	OMEGA 60/100 - SYNTHESIS PNC - EDILUX - ALMA - MUSA	260	8	50+4F+4F			ENG - HGR - SGR	DLC00038	€ 307,00
Blade	OMEGA 60/100 - SYNTHESIS PNC - EDILUX - ALMA - MUSA	260	3	50+4F+4F			ENG - HGR - SGR	DLC00033	€ 254,00

Montresor

TYPE D'OUTIL	MACHINE	D	T	H	V	MATÉRIEL	ROTATION DROITE / ROTATION GAUCHE	NOTE	CODE	PRIX
Calibrating Wheel	LOLA - LUNA - LARA	250	20	50+4F		ENG - HGR - SGR	DX		DLC00050	€ 280,00
Calibrating Wheel	LOLA - LUNA - LARA	250	20	50+4F		ENG - HGR - SGR	SX		DLC00055	€ 280,00
Calibrating Wheel	VELA - LARA	200	22	50		ENG - HGR - SGR	DX	Lara Models > 1982	DLC00056	€ 260,00
Calibrating Wheel	VELA - LARA	200	22	50		ENG - HGR - SGR	SX	Lara Models > 1982	DLC00057	€ 260,00
Calibrating Wheel	VELA - LARA	200	22	50+4F		M	DX	Lara Models > 1982	DLC00104	€ 240,00
Calibrating Wheel	VELA - LARA	200	22	50+4F		M	SX	Lara Models > 1982	DLC00105	€ 300,00
Calibrating Wheel	LARA - UNICA	300	20	50+4F		ENG - HGR - SGR	DX	Lara Models < 1982	DLC00058	€ 390,00
Calibrating Wheel	UNICA	300	20	50+4F		ENG - HGR - SGR	SX		DLC00059	€ 390,00
Pre-Cutting Wheel	LUNA - LARA	130	68	M30	60	ENG - HGR - SGR		No internal works	DLC00039	€ 509,00
Pre-Cutting Wheel	LUNA - LARA	130	68	M30	60	ENG - HGR - SGR		Internal works	DLC00040	€ 541,00
Pre-Cutting Wheel	LUNA	150	68	M30	60	ENG - HGR - SGR		No internal works	DLC00103	€ 610,00
Pre-Cutting Wheel	UNICA	150	74	M30	60	ENG - HGR - SGR			DLC00062	€ 440,00
Bevel cup wheel	LOLA - LUNA	130	40	M30	20	ENG - HGR - SGR			DLC00094	€ 320,00
Bevel cup wheel	VELA	130	20	125+3F	35	ENG - HGR - SGR			DLC00107	€ 270,00
Bevel cup wheel	VELA	87	25,5	71		ENG - HGR - SGR			DLC00119	€ 190,00
Generating Wheel	LUNA	155	60	M30	60	ENG - HGR - SGR		Doppia grana/Double grit	DLC00102	€ 550,00
Generating Wheel	LARA	130	57	M30	60	ENG - HGR - SGR		POS.1	DLC00060	€ 372,00
Generating Wheel	LARA	130	57	M30	60	ENG - HGR - SGR		POS.2	DLC00061	€ 360,00
Generating Wheel	LOLA	150	55	M30 D36,8		ENG - HGR - SGR		Gr. D301	DLC00108	€ 520,00
Generating Wheel	LOLA	150	55	M30 D36,8		ENG - HGR - SGR		Gr. D181	DLC00109	€ 520,00
Generating Wheel	LOLA	150	55	M30 D36,8		ENG - HGR - SGR		Gr. D126	DLC00110	€ 520,00
Drain Groove	LUNA - LOLA	250	6	50+4F+4F		ENG - HGR - SGR			DLC00101	€ 250,00
Drain Groove	LUNA - LOLA	250	8	50+4F+4F		ENG - HGR - SGR			DLC00151	€ 275,00
Drain Groove	LUNA - LOLA	250	10	50+4F+4F		ENG - HGR - SGR			DLC00152	€ 300,00

Montresor disque

MACHINE	MATÉRIEL	D	T	H	TÔLE	NOTE	CODE	PRIX
LUNA - LOLA	M	250	4	50+4F+4F	Normal / Standard		DLC00106	€ 240,00
LUNA - LOLA	M	250	3,2	50+4F+4F	Silencieux		DLC00113	€ 270,00
LUNA - LOLA	ENG - HGR - SGR	260	4	50+4F+4F	Normal / Standard		DLC00115	€ 290,00
LUNA - LOLA	ENG - HGR - SGR	250	3,2	50+4F+4F	Silencieux		DLC00114	€ 324,00
VIVA - LUNA - LOLA	ENG - HGR - SGR	250	2,8	50+4F+4F	Normal / Standard	Settore rinforzato/Reinforced segment	DLC20142	€ 175,00
VIVA	ENG - HGR - SGR	260	2,8	50+4F+4F	Normal / Standard	Settore rinforzato/Reinforced segment	DLC20143	€ 185,00
VIVA - LUNA - LOLA	DK	250	3	50+4F+4F	Normal / Standard		DLC00247	€ 280,00
VIVA	DK	260	3	50+4F+4F	Normal / Standard		DLC00248	€ 305,00

Sassomeccanica

TYPE D'OUTIL	MACHINE	D	T	H	V	MATÉRIEL	CODE	PRIX
Combi wheel	FLYNG FAT - RCM TE	160	8+10	50+6F		ENG - HGR - SGR	DLC00081	€ 380,00
Calibrating Wheel	EXPERIENCE FULL TE / TE	135	18	95+6F		ENG - HGR - SGR	DLC00080	€ 290,00
Pre-Cutting Wheel	EXPERIENCE FULL TE / TE - RCM TE	130	30	95+6F		ENG - HGR - SGR	DLC00083	€ 480,00
Pre-Cutting Wheel	EXPERIENCE FULL TE / TE - RCM TE	130	30	@		ENG - HGR - SGR	DLC00122	€ 530,00
Generating Wheel	EXPERIENCE FULL TE / TE - RCM TE	130	20	95+6F	90	ENG - HGR - SGR	DLC00082	€ 339,00
Generating Wheel	EXPERIENCE FULL TE / TE - RCM TE	130	20	@	90	ENG - HGR - SGR	DLC00116	€ 390,00
Drain Groove	EXPERIENCE FULL TE / TE	160	8	50+6F		ENG - HGR - SGR	DLC00079	€ 285,00
Blade	EXPERIENCE FULL TE	230	3	40		ENG - HGR - SGR	DLC00078	€ 255,00

Breton

TYPE D'OUTIL	MACHINE	D	T	H	V	MATÉRIEL	CODE	PRIX
Pre-Cutting Wheel	PLATINUM	130	36	120+6F		ENG - HGR - SGR	DLC00047	€ 477,00
Generating Wheel	PLATINUM	130	67	M30	60	ENG - HGR - SGR	DLC00046	€ 403,00
Generating Wheel	EASY	170	65	50+4F		ENG - HGR - SGR	DLC00049	€ 670,00

Park Industries

TYPE D'OUTIL	MACHINE	D	T	H	V	MATÉRIEL	CODE	PRIX
Pre-Cutting Wheel	VELOCITY	155	30	35+4F	60	ENG - HGR - SGR	DLC00085	€ 375,00
Generating Wheel	VELOCITY	150	21	125+4F	60	ENG - HGR - SGR	DLC00084	€ 370,00
Generating Wheel	PRO EDGE	100	25	@		ENG - HGR - SGR	DLC00028	€ 159,00
Generating Wheel	PRO EDGE	100	25	@		ENG - HGR - SGR	DLC00029	€ 159,00

POLISSAGE RÉSIN POUR LE CHANT

Sequence grain conseillée pour chant droit

N° HEADS MACHINE LUX	MATERIAL	SUGGESTED SEQUENCE
5	Granit and marbre	60 # 120 # 400 # 1800 # Buffer
5	Engineered stone	120 # 220 # 400 # 800 # Extra Engineered
6	Granit and marbre	60 # 120 # 400 # 800 # 1800 # Buffer
6	Marbre	60 # 120 # 400 # 800 # 1800 # 3500
6	Engineered stone	60 # 120 # 400 # 800 # 1800 # Extra Engineered
7	Granit and marbre	60 # 120 # 220 # 400 # 800 # 1800 # Buffer
7	Marbre	60 # 120 # 220 # 400 # 800 # 1800 # 3500
7	Engineered stone	120 # 220 # 400 # 800 # 1800 # Extra Engineered

Sequence grain conseillée pour arrondi

N° HEADS MACHINE LUX	MATERIAL	SUGGESTED SEQUENCE
5	Granit and marbre	220 # 400 # 600 # 800 # Buffer
5	Marble	220 # 400 # 600 # 800 # 3500
5	Engineered stone	220 # 400 # 600 # 800 # Extra Engineered
6	Granite and marbre	220 # 320 # 400 # 600 # 800 # Buffer
6	Marbre	220 # 320 # 400 # 600 # 800 # 3500
6	Engineered stone	220 # 320 # 400 # 600 # 800 # Extra Engineered
7	Granit and marbre	220 # 280 # 320 # 400 # 600 # 800 # Buffer
7	Engineered stone	220 # 280 # 320 # 400 # 600 # 800 # 3500

Sequence grain conseillée pour arête

N° HEADS MACHINE LUX	MATERIAL	SUGGESTED SEQUENCE
3	Granit, marbre, engineered stone	Metal# 400 # 600#
2	Granit, marbre, engineered stone	220# 400#
1	Granit, marbre, engineered stone	220#

Polissage Resinee

Resinee pour façonnage de forme

D	H	GRAIN	MATÉRIEL	CODE	PRIX
150	@	280	ENG - HGR - SGR	DLC20137	€ 180,00
150	@	400	ENG - HGR - SGR	DLC20138	€ 180,00
150	@	600	ENG - HGR - SGR	DLC20139	€ 180,00
150	@	800	ENG - HGR - SGR	DLC20140	€ 180,00
150	@	1500	ENG - HGR - SGR	DLC20141	€ 180,00
150	@	3500	ENG - HGR - SGR	DLC20144	€ 180,00



Conseillé pour Montresor - LUNA

Resinee chant droit

D	H	GRAIN	TYPE D'ARTICLE	NOTE	MATÉRIEL	CODE	PRIX
150	@	200	Diamant	Elastic	ENG - HGR - SGR	DLC00123	€ 270,00
150	@	200	Polissante		ENG - HGR - SGR	DLC00124	€ 186,00
150	@	400	Polissante		ENG - HGR - SGR	DLC00125	€ 186,00
150	@	800	Polissante		ENG - HGR - SGR	DLC00126	€ 186,00
150	@	1500	Polissante		ENG - HGR - SGR	DLC00127	€ 186,00
150	@	3000	Polissante		ENG - HGR - SGR	DLC00128	€ 186,00
130	@	200	Diamant		ENG - HGR - SGR	DLC00154	€ 189,00
130	@	200	Polissante		ENG - HGR - SGR	DLC00155	€ 170,00
130	@	400	Polissante		ENG - HGR - SGR	DLC00156	€ 170,00
130	@	800	Polissante		ENG - HGR - SGR	DLC00157	€ 170,00
130	@	1500	Polissante		ENG - HGR - SGR	DLC00158	€ 170,00
130	@	3000	Polissante		ENG - HGR - SGR	DLC00159	€ 170,00



DLC00123
DLC00154



DLC00124/5/6/7/8
DLC00155/6/7/8/9

Conseillé pour Montresor - LUNA - VELA (Ø130)

Magnésit chant droit

D	H	GRAIN	MATÉRIEL	CODE	PRIX
150	@	60	ENG - HGR - SGR	DLC00130	€ 14,00
150	@	120	ENG - HGR - SGR	DLC00131	€ 14,00
150	@	220	ENG - HGR - SGR	DLC00132	€ 14,00
150	@	400	ENG - HGR - SGR	DLC00133	€ 14,00
150	@	600	ENG - HGR - SGR	DLC00134	€ 15,00
150	@	800	ENG - HGR - SGR	DLC00135	€ 18,00
150	@	1000	ENG - HGR - SGR	DLC00136	€ 18,00
15	@	BUFF	ENG - HGR - SGR	DLC00121	€ 23,00

Conseillé pour Montresor - LOLA - VELA



Polissante pour biseau

D	H	GRAIN	MATÉRIEL	CODE	PRIX
130	@	200	ENG - HGR - SGR	DLC00137	€ 53,00
130	@	400	ENG - HGR - SGR	DLC00138	€ 53,00
130	@	800	ENG - HGR - SGR	DLC00139	€ 53,00
130	@	1500	ENG - HGR - SGR	DLC00140	€ 53,00
150	@	100	ENG - HGR - SGR	DLC00143	€ 62,00
150	@	320	ENG - HGR - SGR	DLC00141	€ 62,00
150	@	200	ENG - HGR - SGR	DLC00142	€ 62,00

Conseillé pour Montresor - LUNA - LOLA



Resinee chant droit et forme

D	H	GRAIN	MATÉRIEL	CODE	PRIX
150	@	400	ENG - HGR - SGR	DLC00144	€ 62,00
150	@	500	ENG - HGR - SGR	DLC00145	€ 62,00
150	@	800	ENG - HGR - SGR	DLC00146	€ 62,00
150	@	1500	ENG - HGR - SGR	DLC00147	€ 62,00

Conseillé pour Montresor - LUNA - LOLA - VELA



Éponges polissante

D	H	GRAIN	MATÉRIEL	CODE	PRIX
150	@	1000	ENG - HGR - SGR	DLC00149	€ 43,00
150	@	2000	ENG - HGR - SGR	DLC00148	€ 43,00
150	@	3000	ENG - HGR - SGR	DLC00120	€ 43,00
150	@	6000	ENG - HGR - SGR	DLC00150	€ 43,00

Conseillé pour Montresor - LUNA - LOLA - VELA



Diamètre 130mm fixation @ chant droit granit/synthétique

D	H	GRAIN	ROTATION DROITE / ROTATION GAUCHE	MATÉRIEL	CODE	PRIX
130	@	30	DX	ENG - HGR - SGR	DLC20001	€ 62,00
130	@	60	DX	ENG - HGR - SGR	DLC20002	€ 62,00
130	@	120	DX	ENG - HGR - SGR	DLC20003	€ 62,00
130	@	220	DX	ENG - HGR - SGR	DLC20004	€ 62,00
130	@	400	DX	ENG - HGR - SGR	DLC20007	€ 62,00
130	@	600	DX	ENG - HGR - SGR	DLC20008	€ 62,00
130	@	800	DX	ENG - HGR - SGR	DLC20009	€ 62,00
130	@	1800	DX	ENG - HGR - SGR	DLC20010	€ 62,00
130	@	3500	DX	ENG - HGR - SGR	DLC20011	€ 62,00
130	@	BUFF	DX	HGR - SGR	DLC20012	€ 62,00
130	@	5000S	DX	ENG	DLC20097	€ 62,00

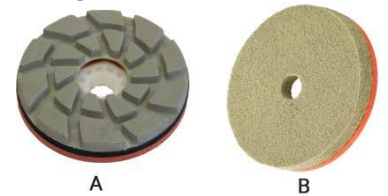

A=DLC20001-12 B=DLC20097

Diamètre 130mm fixation @ chant droit granit/synthétique fixation gauche

D	H	GRAIN	ROTATION DROITE / ROTATION GAUCHE	MATÉRIEL	CODE	PRIX
130	@	30	SX	ENG - HGR - SGR	DLC20013	€ 62,00
130	@	60	SX	ENG - HGR - SGR	DLC20014	€ 62,00
130	@	120	SX	ENG - HGR - SGR	DLC20015	€ 62,00
130	@	220	SX	ENG - HGR - SGR	DLC20016	€ 62,00
130	@	400	SX	ENG - HGR - SGR	DLC20019	€ 62,00
130	@	600	SX	ENG - HGR - SGR	DLC20020	€ 62,00
130	@	800	SX	ENG - HGR - SGR	DLC20021	€ 62,00
130	@	1800	SX	ENG - HGR - SGR	DLC20022	€ 62,00
130	@	3500	SX	ENG - HGR - SGR	DLC20023	€ 62,00
130	@	BUFF	SX	HGR - SGR	DLC20024	€ 62,00
130	@	5000S	SX	ENG	DLC20098	€ 62,00

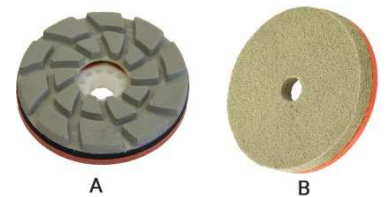

A=DLC20013-24 B=DLC20098

Diamètre 130 mm fixation @ formes granit/synthétique

D	H	GRAIN	ROTATION DROITE / ROTATION GAUCHE	MATÉRIEL	CODE	PRIX
130	@	30	DX	ENG - HGR - SGR	DLC20025	€ 92,00
130	@	60	DX	ENG - HGR - SGR	DLC20026	€ 92,00
130	@	120	DX	ENG - HGR - SGR	DLC20027	€ 92,00
130	@	220	DX	ENG - HGR - SGR	DLC20028	€ 92,00
130	@	280	DX	ENG - HGR - SGR	DLC20029	€ 92,00
130	@	320	DX	ENG - HGR - SGR	DLC20030	€ 92,00
130	@	400	DX	ENG - HGR - SGR	DLC20031	€ 92,00
130	@	600	DX	ENG - HGR - SGR	DLC20032	€ 92,00
130	@	800	DX	ENG - HGR - SGR	DLC20033	€ 92,00
130	@	1800	DX	ENG - HGR - SGR	DLC20034	€ 92,00
130	@	3500	DX	ENG - HGR - SGR	DLC20035	€ 92,00
130	@	BUFF	DX	HGR - SGR	DLC20036	€ 92,00
130	@	5000S	DX	ENG	DLC20099	€ 92,00

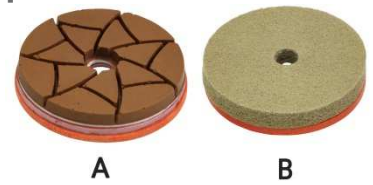

Grain 30 et 60 pour machine mono tête
A=DLC20025-36 B=DLC20099

Diamètre 130 mm fixation @ formes granit/synthétique

D	H	GRAIN	ROTATION DROITE / ROTATION GAUCHE	MATÉRIEL	CODE	PRIX
130	@	30	SX	ENG - HGR - SGR	DLC20037	€ 92,00
130	@	60	SX	ENG - HGR - SGR	DLC20038	€ 92,00
130	@	120	SX	ENG - HGR - SGR	DLC20039	€ 92,00
130	@	220	SX	ENG - HGR - SGR	DLC20040	€ 92,00
130	@	280	SX	ENG - HGR - SGR	DLC20041	€ 92,00
130	@	320	SX	ENG - HGR - SGR	DLC20042	€ 92,00
130	@	400	SX	ENG - HGR - SGR	DLC20043	€ 92,00
130	@	600	SX	ENG - HGR - SGR	DLC20044	€ 92,00
130	@	800	SX	ENG - HGR - SGR	DLC20045	€ 92,00
130	@	1800	SX	ENG - HGR - SGR	DLC20046	€ 92,00
130	@	3500	SX	ENG - HGR - SGR	DLC20047	€ 92,00
130	@	BUFF	SX	HGR - SGR	DLC20048	€ 92,00
130	@	5000S	SX	ENG	DLC20100	€ 62,00



Grain 30 et 60 pour machine mono tête
A=DLC20037-48 B=DLC20100

Diamètre 150 mm fixation @ chant droit granit/synthétique

D	H	GRAIN	ROTATION DROITE / ROTATION GAUCHE	MATÉRIEL	CODE	PRIX
150	@	30	DX	ENG - HGR - SGR	DLC20110	€ 77,00
150	@	60	DX	ENG - HGR - SGR	DLC20111	€ 77,00
150	@	120	DX	ENG - HGR - SGR	DLC20112	€ 77,00
150	@	220	DX	ENG - HGR - SGR	DLC20113	€ 77,00
150	@	400	DX	ENG - HGR - SGR	DLC20114	€ 77,00
150	@	600	DX	ENG - HGR - SGR	DLC20115	€ 77,00
150	@	800	DX	ENG - HGR - SGR	DLC20116	€ 77,00
150	@	1800	DX	ENG - HGR - SGR	DLC20117	€ 77,00
150	@	3500	DX	ENG - HGR - SGR	DLC20118	€ 77,00
150	@	BUFF	DX	HGR - SGR	DLC20119	€ 77,00
150	@	5000S	DX	ENG	DLC20120	€ 77,00

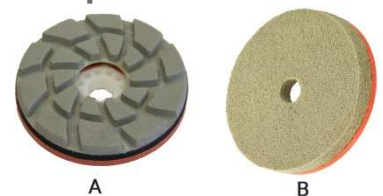

A=DLC20110-9 B=DLC20120

Diamètre 150 mm fixation @ chant droit granit/synthétique

D	H	GRAIN	ROTATION DROITE / ROTATION GAUCHE	MATÉRIEL	CODE	PRIX
150	@	30	DX	ENG - HGR - SGR	DLC20049	€ 77,00
150	@	60	DX	ENG - HGR - SGR	DLC20050	€ 77,00
150	@	120	DX	ENG - HGR - SGR	DLC20051	€ 77,00
150	@	220	DX	ENG - HGR - SGR	DLC20052	€ 77,00
150	@	400	DX	ENG - HGR - SGR	DLC20055	€ 77,00
150	@	600	DX	ENG - HGR - SGR	DLC20056	€ 77,00
150	@	800	DX	ENG - HGR - SGR	DLC20057	€ 77,00
150	@	1800	DX	ENG - HGR - SGR	DLC20058	€ 77,00
150	@	3500	DX	ENG - HGR - SGR	DLC20059	€ 77,00
150	@	BUFF	DX	HGR - SGR	DLC20060	€ 77,00
150	@	5000S	DX	ENG	DLC20101	€ 77,00

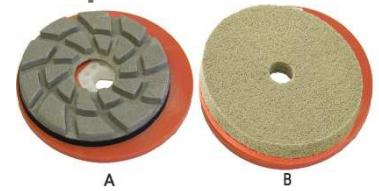

A=DLC20049-60 B=DLC20101

Diamètre 150 mm fixation @ chant droit granit/synthétique fixation gauche

D	H	GRAIN	ROTATION DROITE / ROTATION GAUCHE	MATÉRIEL	CODE	PRIX
150	@	30	SX	ENG - HGR - SGR	DLC20061	€ 77,00
150	@	60	SX	ENG - HGR - SGR	DLC20062	€ 77,00
150	@	120	SX	ENG - HGR - SGR	DLC20063	€ 77,00
150	@	220	SX	ENG - HGR - SGR	DLC20064	€ 77,00
150	@	400	SX	ENG - HGR - SGR	DLC20067	€ 77,00
150	@	600	SX	ENG - HGR - SGR	DLC20068	€ 77,00
150	@	800	SX	ENG - HGR - SGR	DLC20069	€ 77,00
150	@	1800	SX	ENG - HGR - SGR	DLC20070	€ 77,00
150	@	3500	SX	ENG - HGR - SGR	DLC20071	€ 77,00
150	@	BUFF	SX	HGR - SGR	DLC20072	€ 77,00
150	@	5000S	SX	ENG	DLC20102	€ 77,00

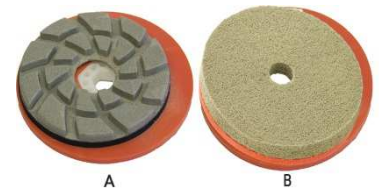

A=DLC20061-72 B=DLC20102

Diamètre 150 mm fixation @ formes granit/synthétique

D	H	GRAIN	ROTATION DROITE / ROTATION GAUCHE	MATÉRIEL	CODE	PRIX
150	@	30	DX	ENG - HGR - SGR	DLC20073	€ 106,00
150	@	60	DX	ENG - HGR - SGR	DLC20074	€ 106,00
150	@	120	DX	ENG - HGR - SGR	DLC20075	€ 106,00
150	@	220	DX	ENG - HGR - SGR	DLC20076	€ 106,00
150	@	280	DX	ENG - HGR - SGR	DLC20077	€ 106,00
150	@	320	DX	ENG - HGR - SGR	DLC20078	€ 106,00
150	@	400	DX	ENG - HGR - SGR	DLC20079	€ 106,00
150	@	600	DX	ENG - HGR - SGR	DLC20080	€ 106,00
150	@	800	DX	ENG - HGR - SGR	DLC20081	€ 106,00
150	@	1800	DX	ENG - HGR - SGR	DLC20082	€ 106,00
150	@	3500	DX	ENG - HGR - SGR	DLC20083	€ 106,00
150	@	BUFF	DX	HGR - SGR	DLC20084	€ 106,00
150	@	5000S	DX	ENG	DLC20103	€ 106,00

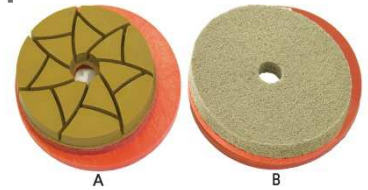

Grain 30 et 60 pour machine mono tête
A=DLC20073-84 B=DLC20103

Diamètre 150 mm fixation @ formes granit/synthétique fixation gauche

D	H	GRAIN	ROTATION DROITE / ROTATION GAUCHE	MATÉRIEL	CODE	PRIX
150	@	30	SX	ENG - HGR - SGR	DLC20085	€ 106,00
150	@	60	SX	ENG - HGR - SGR	DLC20086	€ 106,00
150	@	120	SX	ENG - HGR - SGR	DLC20087	€ 106,00
150	@	220	SX	ENG - HGR - SGR	DLC20088	€ 106,00
150	@	280	SX	ENG - HGR - SGR	DLC20089	€ 106,00
150	@	320	SX	ENG - HGR - SGR	DLC20090	€ 106,00
150	@	400	SX	ENG - HGR - SGR	DLC20091	€ 106,00
150	@	600	SX	ENG - HGR - SGR	DLC20092	€ 106,00
150	@	800	SX	ENG - HGR - SGR	DLC20093	€ 106,00
150	@	1800	SX	ENG - HGR - SGR	DLC20094	€ 106,00
150	@	3500	SX	ENG - HGR - SGR	DLC20095	€ 106,00
150	@	BUFF	SX	HGR - SGR	DLC20096	€ 106,00
150	@	5000S	SX	ENG	DLC20104	€ 106,00

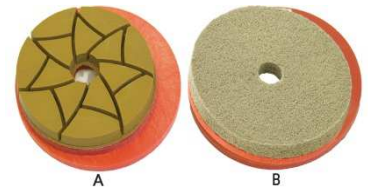

Grain 30 et 60 pour machine mono tête
A=DLC20085-96 B=DLC20104

Diamètre 130 mm fixation @ pour chanfreins granit/synthétique

D	H	GRAIN	ROTATION		MATÉRIEL	CODE	PRIX
			ROITE / ROTATION GAUCHE				
130	@	220	DX		ENG - HGR - SGR	DLC20105	€ 75,00
130	@	320	DX		ENG - HGR - SGR	DLC20106	€ 75,00
130	@	400	DX		ENG - HGR - SGR	DLC20107	€ 75,00
130	@	600	DX		ENG - HGR - SGR	DLC20108	€ 75,00



Chant droit meule OCTO (haute qualité)

D	H	GRAIN	ROTATION DROITE / ROTATION GAUCHE	CODE	PRIX
150	@	100	DX	DRI70681	€ 133,00
150	@	200	DX	DRI70682	€ 133,00
150	@	500	DX	DRI70683	€ 133,00
150	@	1000	DX	DRI70684	€ 133,00
150	@	2000	DX	DRI70685	€ 133,00
150	@	3000	DX	DRI70686	€ 133,00
150	@	BUFF	DX	DRI70687	€ 133,00
125	@	100	DX	DRI79262	€ 98,00
125	@	200	DX	DRI79263	€ 98,00
125	@	500	DX	DRI79264	€ 98,00
125	@	1000	DX	DRI79265	€ 98,00
125	@	2000	DX	DRI79266	€ 98,00
125	@	3000	DX	DRI79267	€ 98,00
125	@	BUFF	DX	DRI79308	€ 98,00



Pour synthétique/quartz, matériel composite, granit, marbre, Dekton

Resinee pour façonnage de forme

D	H	GRAIN	MATÉRIEL	CODE	PRIX
125	@	280	ENG - HGR - SGR	DLC20155	€ 165,00
125	@	400	ENG - HGR - SGR	DLC20156	€ 165,00
125	@	600	ENG - HGR - SGR	DLC20157	€ 165,00
125	@	800	ENG - HGR - SGR	DLC20158	€ 165,00
125	@	1500	ENG - HGR - SGR	DLC20159	€ 165,00
125	@	3500	ENG - HGR - SGR	DLC20160	€ 165,00



Diamètre 125 mm fixation @ pour chanfreins granit/synthétique (haute qualité)

D	H	GRAIN	MATÉRIEL	CODE	PRIX
125	@	280	ENG - HGR - SGR	DLC20177	€ 165,00
125	@	400	ENG - HGR - SGR	DLC20178	€ 165,00
125	@	600	ENG - HGR - SGR	DLC20179	€ 165,00
125	@	800	ENG - HGR - SGR	DLC20180	€ 165,00
125	@	1500	ENG - HGR - SGR	DLC20181	€ 165,00
125	@	3500	ENG - HGR - SGR	DLC20182	€ 165,00



DISQUE POUR COUPE À EAU

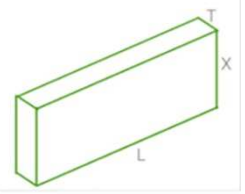
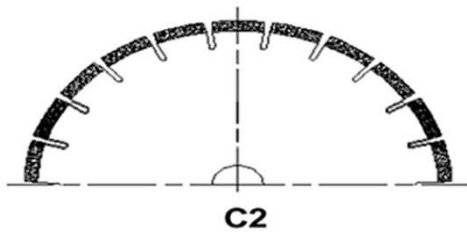

PARAMETRES DE TRAVAIL

Granit - Marbre

	GRANIT TENDRE Category 1/3 VP=32/35	MEDIUM GRANITE & ENGINEERED STONE Category 4 VP=29/31	GRANIT DURE Category 5/6 VP=26/30	MARBRE
D	RPM	RPM	RPM	RPM
300	2040 - 2230	1850 - 1950	1650 - 1910	2870 - 3500
350	1750 - 1910	1580 - 1690	1420 - 1640	2460 - 3000
400	1530 - 1675	1385 - 1480	1240 - 1430	2150 - 2630
450	1360 - 1490	1230 - 1320	1100 - 1270	1910 - 2340
500	1125 - 1340	1100 - 1190	100 - 1150	1720 - 2100
600	1020 - 1115	930 - 990	830 - 960	1430 - 1750
625	980 - 1070	890 - 950	800 - 920	1380 - 1680
725	845 - 925	765 - 820	685 - 790	1190 - 1450
Avance mm/min*	1500 - 5000	1200 - 3700	800 - 2800	1500 - 2800

Dekton

D	RPM	AVANCE mm/min		AVANCE mm/min cut 45°	
		Couleurs sombres	Couleurs blanches ou claires	Couleurs sombres	Couleurs blanches ou claires
350	1600 - 2000	600 - 1000	600 - 800	400 - 800	400 - 500
400	1400 - 1800	600 - 1000	600 - 1000	400 - 800	400 - 500
450	1300 - 1700	600 - 1000	600 - 1000	400 - 800	400 - 500

Epaisseur tranche (mm)= 8 ; 12; 20

Materiaux ceramiqué

D	RPM	AVANCE mm/min	AVANCE mm/min cut 45°
350	1600 - 2000	600 - 2000	700 - 900
400	1400 - 1800	600 - 2000	700 - 900
450	1300 - 1700	600 - 2000	700 - 900

Epaisseur tranche (mm)= 6 ; 8 ; 10 ; 12 ; 20

*L'avance dépend de l'épaisseur de la tranche, type de disque (standard-haute performance), type de matériel, type de machine, la puissance du moteur et l'arrosage interne.

Recommandons de réduire de 50% les vitesses durant l'entrée et la sortie du matériel, il est conseillé de sortir de de 2mm durant la coupe. les paramètres sont soumis à des variations selon le matériel, machine et conditions de travail. NB. il est fondamentale que le disque soit arrosé suffisamment et pas trop pour se raviver et couper dans de bonnes conditions. un arosage insuffisant réduit les performances de coupe et la durée de vie du disque.

Granit et synthétique

Disque pour débiteuse

D	T	H	Z	L	X	TÔLE	CODE	PRIX
350	3	50/60	24	40	15	Silencieux	DDSU00392	€ 125,00
400	3,2	50/60	28	40	15	Silencieux	DDSU00393	€ 155,00
450	3,6	50/60	32	40	15	Silencieux	DDSU00407	€ 215,00
500	3,6	50/60	36	40	15	Silencieux	DDSU00394	€ 245,00
600	4,2	50/60	42	40	15	Silencieux	DDSU00395	€ 390,00
350	3	50/60	24	40	15	Normal / Standard	DDSU00461	€ 105,00
400	3,2	50/60	28	40	15	Normal / Standard	DDSU00462	€ 135,00
450	3,6	50/60	32	40	15	Normal / Standard	DDSU00463	€ 195,00
500	3,6	50/60	36	40	15	Normal / Standard	DDSU00464	€ 215,00
600	4,2	50/60	42	40	15	Normal / Standard	DDSU00465	€ 370,00

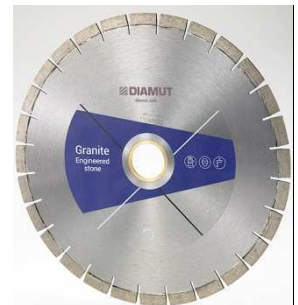

Tipo disco C2

Donatoni

D	T	H	Z	L	X	TÔLE	CODE	PRIX
350	3	50/60+1F	24	40	15	Silencieux	DDSU00466	€ 125,00
400	3,2	50/60+1F	28	40	15	Silencieux	DDSU00414	€ 155,00
450	3,6	50/60+1F	32	40	15	Silencieux	DDSU00467	€ 215,00
500	3,6	65/50+1F	36	40	15	Silencieux	DDSU00408	€ 245,00
400	3	50/60+1F	28	40	20	Silencieux	DDSU00418	€ 310,00

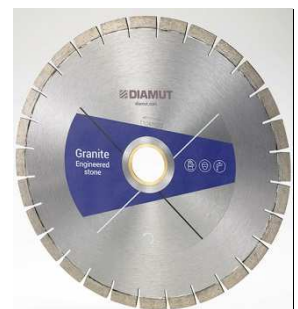

Tipo disco C2

Disque pour débiteuse DONATONI + BRETON

D	T	H	Z	L	X	TÔLE	CODE	PRIX
350	3	60/50+1F+2 F	42	20	18	Silencieux	DDSU00446	€ 205,00
400	3,2	60/50+1F+2 F	48	20	18	Silencieux	DDSU00387	€ 215,00
450	3,6	60/50+1F+2 F	52	20	18	Silencieux	DDSU00388	€ 285,00
500	3,6	60/50+1F+2 F	60	20	18	Silencieux	DDSU00447	€ 315,00
625	4,5	60/50+1F+2 F	72	20	18	Silencieux	DDSU00448	€ 445,00

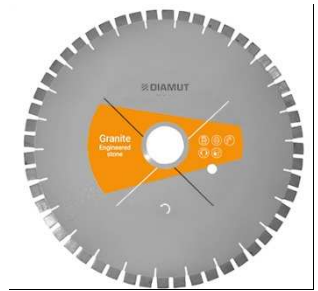

Tipo disco C4P

Marbre

Disque pour débiteuse

D	T	H	Z	L	X	TÔLE	CODE	PRIX
350	3,3	50/60	25	40	7,5	Silencieux	DDSU00396	€ 160,00
400	3,6	50/60	28	40	7,5	Silencieux	DDSU00390	€ 180,00
450	3,8	50/60	32	40	7,5	Silencieux	DDSU00480	€ 215,00
500	4,1	50/60	36	40	7,5	Silencieux	DDSU00397	€ 260,00
600	5	50/60	42	40	7,5	Silencieux	DDSU00398	€ 440,00
625	5	50/60	42	40	7,5	Silencieux	DDSU00406	€ 440,00
350	3,3	50/60	25	40	7,5	Normal / Standard	DDSU00453	€ 140,00
400	3,6	50/60	28	40	7,5	Normal / Standard	DDSU00454	€ 160,00
450	3,8	50/60	32	40	7,5	Normal / Standard	DDSU00455	€ 195,00
500	4,1	50/60	36	40	7,5	Normal / Standard	DDSU00456	€ 220,00
600	5	50/60	42	40	7,5	Normal / Standard	DDSU00457	€ 400,00
625	5	50/60	42	40	7,5	Normal / Standard	DDSU60024	€ 400,00



Donatoni

D	T	H	Z	L	X	TÔLE	CODE	PRIX
350	3,3	50/60+1F	25	40	7,5	Silencieux	DDSU00458	€ 160,00
400	3,6	50/60+1F	28	40	7,5	Silencieux	DDSU00425	€ 180,00
400	3,6	50/65+1F	28	40	7,5	Silencieux	DDSU00430	€ 180,00
450	3,8	50/60+1F	32	40	7,5	Silencieux	DDSU00459	€ 215,00
500	4,1	50/60+1F	36	40	7,5	Silencieux	DDSU00429	€ 260,00
600	5	50/60+1F	42	40	7,5	Silencieux	DDSU00460	€ 440,00
725	6,5	50/60+1F	50	40	7,5	Normal / Standard	DDSU00427	€ 590,00

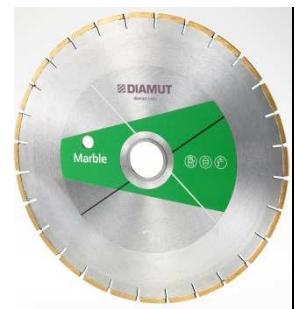

Tipo disco C2

Dekton + Matériaux céramique

Disque pour débiteuse DONATONI + BRETON

D	T	H	Z	L	X	TÔLE	CODE	PRIX
350		60/50+1F+2 F	27	40	10	Silencieux	DDSU00523	€ 220,00
400		60/50+1F+2 F	30	40	10	Silencieux	DDSU00524	€ 295,00
450		60/50+1F+2 F	34	40	10	Silencieux	DDSU00525	€ 390,00
500		60/50+1F+2 F	38	40	10	Silencieux	DDSU00526	€ 415,00

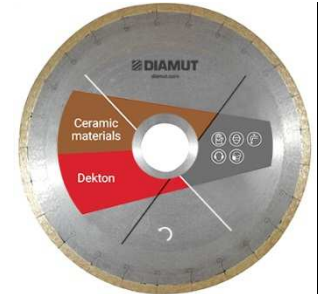

Disque de coupe avec corps renforce DONATONI + BRETON

D	T	H	Z	L	X	TÔLE	CODE	PRIX
400		60/50+1F+2 F	30	40	10	Silencieux	DDSU00527	€ 360,00
450		60/50+1F+2 F	34	40	10	Silencieux	DDSU00528	€ 440,00

Conseillé pour coupe inclinée

Adaptateur

D	H	T	MATÉRIEL	CODE	PRIX
60	50	2,8	Bronzo/Bronze	D10420	€ 10,00
60	50	3,3	Bronzo/Bronze	D12823	€ 10,00
60	50	4,5	Bronzo/Bronze	D12857	€ 10,00
60	40	3,3	Bronzo/Bronze	D10497	€ 10,00
65	60	2,5	Bronzo/Bronze	D12820	€ 10,00
65	50	2,5	Bronzo/Bronze	D12821	€ 10,00
65	60	3,3	Bronzo/Bronze	D12822	€ 10,00

DISQUE POUR COUPE À SEC

Granit

Granit avec trou de refroidissement de tôle modèle D

D	H	FLASQUE	T	X	CODE	PRIX
115	22,2		2,1	10	DDSS00043	€ 15,00
125	M14	Yes	2,1	10	DDSS00044	€ 22,00
150	M14	Yes	2,1	10	DDSS00045	€ 26,00
180	M14	Yes	2,4	10	DDSS00046	€ 30,00
230	22,2		2,6	10	DDSS00047	€ 34,00
230	M14	Yes	2,6	10	DDSS00048	€ 34,00



Granit avec renfort latéral modèle DR

D	H	FLASQUE	T	X	CODE	PRIX
115	22,2		2,2	10	DDSS00049	€ 17,00
115	M14	Yes	2,2	10	DDSS00050	€ 23,00
125	M14	Yes	2,4	10	DDSS00051	€ 30,00
150	M14	Yes	2,2	10	DDSS00052	€ 34,00
180	M14	Yes	2,6	10	DDSS00053	€ 37,00
230	22,2		2,6	10	DDSS00054	€ 36,00
230	M14	Yes	2,6	10	DDSS00055	€ 45,00



Disque bombé

D	H	FLASQUE	T	X	CODE	PRIX
125	22,2		3	7	DDSS00058	€ 122,00
180	22,2		3	7	DDSS00059	€ 145,00



Marbre électrodéposé

D	H	FLASQUE	T	X	CODE	PRIX
125	M14	Yes		2,3	DDSS00023	€ 36,00
150	M14	Yes		2,3	DDSS00024	€ 46,00
180	22,2	Yes		2,8	DDSS00025	€ 55,00
230	22,2	Yes		2,8	DDSS00026	€ 62,00



Gres

Avec renfort central

D	H	T	X	CODE	PRIX
115	22,2	1,2	7	DDSS00057	€ 21,00



Plateau turbo avec corps en aluminium

D	H	FLASQUE	T	X	CODE	PRIX
100	M14	Yes		5	DDSS00060	€ 50,00



DISQUE POUR CENTRE INTERMAC

Diamètre 180 pour coupe en forme

MATÉRIEL	D	T	H	Z	V	X	TÔLE	MACHINE / CODE AGRÉGAT	CODE	PRIX
HGR - SGR	180	4	30+4F	16	15	12	Normal / Standard	Master 22-23-43 - 33.3- 38.3-45.3 / P6314P0027 Master 35-45-55-65- 33.5-38.5-45.5 / P6314P0045	DDSG00099	€ 493,00
HGR - SGR	180	4	30+4F	16	30	12	Normal / Standard	Master 22-33-43-53-63- 33.3-38.3-45.3 / P6314P0015 Master 35-45-55-65-JET- PRO-33.5-38.5-45.5 / P6314P0045	DDSG00102	€ 493,00

Diamètre 200 mm

MATÉRIEL	D	T	H	Z	V	X	TÔLE	MACHINE / CODE AGRÉGAT	CODE	PRIX
HGR - SGR	200	3	30+4F	17		10	Normal / Standard	Master 23-33-43-53-63- 33.3-38.3-45.3 / P6314P0015 Master 35-45-55-65-JET- PRO-33.5-38.5-45.5 / P6314P0063	DDSG00103	€ 253,00
M	200	2,8	30+4F	17		7	Normal / Standard	Master 23-33-43-53-63- 33.3-38.3-45.3 / P6314P0015 Master 35-45-55-65-JET- PRO-33.5-38.5-45.5 / P6314P0063	DDSM00047	€ 207,00

Diamètre 250 mm

MATÉRIEL	D	T	H	Z	V	X	TÔLE	MACHINE / CODE AGRÉGAT	CODE	PRIX
HGR - SGR	250	3	30+4F	17		10	Silencieux	Master 23-33-43-53-63- 33.3-38.3-45.3 / P6314P0015 Master 35-45-55-65-JET- PRO-33.5-38.5-45.5 / P6314P0063	DDSG00042	€ 312,00

Diamètre 350 mm

MATÉRIEL	D	T	H	Z	V	X	TÔLE	MACHINE / CODE AGRÉGAT	CODE	PRIX
HGR - SGR	350	5	50+6F	21		10	Silencieux	Master 35-45-55-65- 33.5-38.5-45.5 / P6314P0021	DDSG00022	€ 435,00
M	350	3,4	50+6F	25		10	Silencieux	Master 35-45-55-65- 33.5-38.5-45.5 / P6314P0021	DDSM00032	€ 240,00

Diamètre 500 mm

MATÉRIEL	D	T	H	Z	V	X	TÔLE	MACHINE / CODE AGRÉGAT	CODE	PRIX
HGR - SGR	500	3,6	75+6F	30		12	Silencieux	Master 45 Plus - Top Master -33.5-38.5-45.5 / P6314P0042	DDSG00058	€ 535,00
M	500	4,4	75+6F	36		7	Silencieux	Master 45 Plus - Top Master -33.5-38.5-45.5 / P6314P0042	DDSM00052	€ 490,00

Diamètre 625 mm

MATÉRIEL	D	T	H	Z	V	X	TÔLE	MACHINE / CODE AGRÉGAT	CODE	PRIX
HGR - SGR	625	5	60+4F	36		10	Silencieux	Master 850 - 1200 - Master Saw 625 double table	DDSU00331	€ 745,00
HGR - SGR	625	5,5	60+4F	36		10	Normal / Standard	Master 850 - 1200 - Master Saw 625 double table	DDSU60020	€ 730,00
M	625	5,5	60+4F	42		7	Silencieux	Master 850 - 1200 - Master Saw 625 double table	DDSU00190	€ 655,00

Diamètre 230 pour coupe à 44°

MATÉRIEL	D	T	H	Z	V	X	TÔLE	MACHINE / CODE AGRÉGAT	CODE	PRIX
HGR - SGR	230	3	30+4F	17		10	Normal / Standard	Aggregate PCC4005019	DDSU00099	€ 295,00

Disco diametro 150 mm per taglio innesto rinforzo piani cucina RODDING

MATÉRIEL	D	T	H	Z	V	X	TÔLE	MACHINE / CODE AGRÉGAT	CODE	PRIX
HGR - SGR	150	4	22+6F	11		10	Normal / Standard	Aggregate PCC4005017	DDSU00381	€ 340,00

OUTILS POUR DEKTON®

FORÊTS

Forêt couronne continue attache 1/2" gas pour CNC

Longeur totale 95mm et longueur utile 50mm

D	L	L1	RPM	AVANCE mm/min	CODE	PRIX
10	95	50	2500-4000	15-25	DDKFGR000010	€ 59,00
15	95	50	2500-4000	15-25	DDKFGR000015	€ 63,00
18	95	50	2500-4000	15-25	DDKFGR000018	€ 65,00
20	95	50	2500-4000	15-25	DDKFGR000020	€ 75,00
22	95	50	1800-2500	15-25	DDKFGR000022	€ 75,00
25	95	50	1800-2500	15-25	DDKFGR000025	€ 84,00
30	95	50	1800-2500	15-25	DDKFGR000030	€ 90,00
32	95	50	1000-1800	15-25	DDKFGR000032	€ 98,00
35	95	50	1000-1800	15-25	DDKFGR000035	€ 105,00
40	95	50	1000-1800	15-25	DDKFGR000040	€ 120,00
70	95	50	1000-1200	15-25	DDKFGR000070	€ 135,00



FRAISE

Fraise a secteur attache 1/2" pour CNC

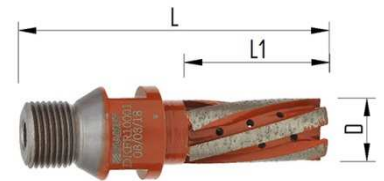

D	L1	Z	RPM	FEED mm/min	CODE	PRIX
20	25	5	7000-8000	200-300	DDKFR10002	€ 128,00
20	30	5	7000-8000	200-300	DDKFR10004	€ 135,00
20	45	5	7000-8000	200-300	DDKFR10001	€ 140,00

Pastille pour coupe multi passe

D	H	X	RPM	AVANCE mm/min	CODE	PRIX
20	M12	20	6000-8000	500-750	DDKPT01	€ 157,00

Diamètre support 18mm



TYPE D'OUTIL	H	ALESAGE	L	CODE	PRIX
Support	1/2 GAS	M12	75	D12109	€ 80,00

MEULE PERIPHERIQUE POUR DEKTON[®]

Séquence et type de meules diamant pour CNC



POS.1	POS.2	POS.3	POS.4	POS.5	POS.6
1E	2N	3R			
MEULE DIAMANT A SECTEUR AVEC REFROIDISSEMENT INTERNE	MEULE DIAMANT A SECTEUR AVEC REFROIDISSEMENT INTERNE	MEULE COURONNE CONTINUE AVEC REFROIDISSEMENT INTERNE	POLISSANTE AVEC REFROIDISSEMENT INTERNE	POLISSANTE AVEC REFROIDISSEMENT INTERNE	POLISSANTE AVEC REFROIDISSEMENT INTERNE

Parametres de travail:

POS	D	RPM	FEED mm/min	ENLEVEMENT (mm)	D	RPM	FEED mm/min	ENLEVEMENT (mm)
1	120	5000	2500-3000	0,3-0,4	20	7000-8000	800-1000	0,3 0,4
2	120	5000	2500-3000	0,1-0,2	20	7000-8000	800-1000	0,2
3	120	5000	2500-3000	0,1	20	7000-8000	800-1000	0,1
4	120	3400	2500-3000	0,1	20	4000-4500	1000	0,1
5	120	3400	1000	0,1	20	4000-4500	1000	0,1
6	120	800	1000	0,2	20	4000-4500	1000	0,1
1	80	5500	2500-3000	0,3-0,4	25	7000-8000	800-1000	0,3 0,4
2	80	5500	2500-3000	0,1-0,2	25	7000-8000	800-1000	0,2
3	80	5500	2500-3000	0,1	25	7000-8000	800-1000	0,1
4	80	3400	2500-3000	0,1	25	4000-4500	1000	0,1
5	80	3400	1000	0,1	25	4000-4500	1000	0,1
6	80	800	1000	0,2	25	4000-4500	1000	0,1

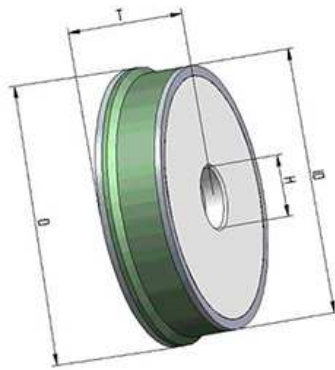

Pour epaisseur 20 mm

A

POS	D	ID	H	T	TYPE D'ARTICLE	CODE	PRIX
1	80	67	35	33	Gros secteur	DDK82291	€ 380,00
2	80	67	35	33	Medium segmented	DDK82292	€ 380,00
3	80	67	35	32	Couronne continue fine	DDK82293	€ 400,00
4	72	60	35	42	Polissante	DLK30767	€ 196,00
5	72	60	35	42	Polissante	DLK30768	€ 196,00
6	80	68	35	40	Cerium	DLK20021	€ 120,00

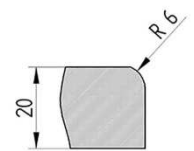

D

POS	D	ID	H	T	TYPE D'ARTICLE	CODE	PRIX
1	120	102	35	32	Gros secteur	DDK10013	€ 470,00
2	120	102	35	32	Medium segmented	DDK10014	€ 470,00
3	120	102	35	32	Couronne continue fine	DDK10015	€ 600,00
4	80	60	35	42	Polissante	DLK20013	€ 196,00
5	80	60	35	42	Polissante	DLK20014	€ 196,00
6	120	102	35	40	Cerium	DLK20015	€ 140,00

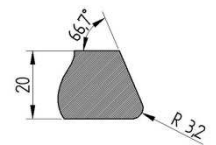

Profil T - diamètre 80 mm

POS	D	ID	H	T	TYPE D'ARTICLE	CODE	PRIX
1	80	72	22	32	Gros secteur	DDK10016	€ 380,00
2	80	72	22	32	Medium segmented	DDK71688	€ 380,00
3	80	72	22	32	Couronne continue fine	DDK71689	€ 400,00
4	66	60	22	42	Polissante	DLK30010	€ 196,00
5	66	60	22	42	Polissante	DLK30011	€ 196,00
6	80	74	22	40	Cerium	DLK20016	€ 120,00

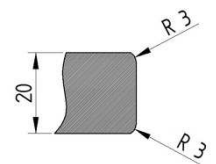

Profil T - diamètre 60 mm

POS	D	ID	H	T	TYPE D'ARTICLE	CODE	PRIX
1	60	54	22	23	Gros secteur	DDK10035	€ 329,00
2	60	52	22	28	Medium segmented	DDK71770	€ 329,00
3	60	52	22	34	Couronne continue fine	DDK71771	€ 329,00
4	61	50	22	42	Polissante	DLK30166	€ 180,00
5	61	50	22	42	Polissante	DLK30167	€ 180,00
6	60	54	22	40	Cerium	DLK10917	€ 120,00

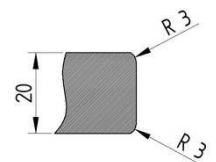

Profil Trapezoidale - diamètre 120 mm

POS	D	ID	H	T	TYPE D'ARTICLE	CODE	PRIX
1	120	113	22	36	Gros secteur	DDK10020	€ 470,00
2	120	113	22	36	Medium segmented	DDK76972	€ 470,00
3	120	113	22	32	Couronne continue fine	DDK76973	€ 600,00
4	67	60	35	52	Polissante	DLK30142	€ 192,00
5	67	60	35	52	Polissante	DLK30143	€ 192,00
6	80	73	35	40	Cerium	DLK30144	€ 120,00

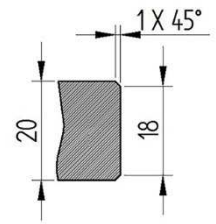

Profil Trapezoidale - diamètre 80 mm

POS	D	ID	H	T	TYPE D'ARTICLE	CODE	PRIX
1	80	73	22	28	Gros secteur	DDK83896	€ 380,00
2	80	73	22	28	Medium segmented	DDK81348	€ 380,00
3	80	73	22	32	Couronne continue fine	DDK81349	€ 400,00
4	66	60	22	42	Polissante	DLK31702	€ 189,00
5	66	60	22	42	Polissante	DLK31703	€ 189,00
6	80	74	22	40	Cerium	DLK31704	€ 120,00

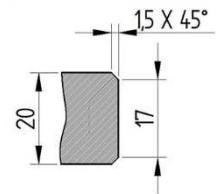

Profil z - diamètre 120 mm

POS	D	ID	H	T	TYPE D'ARTICLE	CODE	PRIX
1	120	120	22	22	Gros secteur	DDK72707	€ 450,00
2	120	120	35	22	Medium segmented	DDK71202	€ 450,00
3	120	120	35	22	Couronne continue fine	DDK71203	€ 466,00
4	80	80	35	22	Polissante	DLK30085	€ 196,00
5	80	80	35	22	Polissante	DLK30086	€ 196,00
6	120	120	35	40	Cerium	DLK10103	€ 132,00

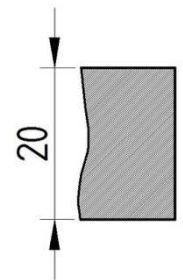

Profil Z - diamètre 80 mm

POS	D	ID	H	T	TYPE D'ARTICLE	CODE	PRIX
1	80	80	35	22	Gros secteur	DDK74430	€ 370,00
2	80	80	35	22	Medium segmented	DDK74302	€ 370,00
3	80	80	35	22	Couronne continue fine	DDK74303	€ 390,00
4	80	80	35	22	Polissante	DLK30085	€ 196,00
5	80	80	35	22	Polissante	DLK30086	€ 196,00
6	80	80	35	40	Cerium	DLK12190	€ 120,00

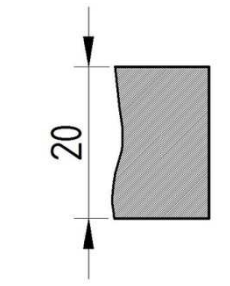

Meule pour profil 45°

Pour tranche épaisseur 30 mm

POS	D	ID	H	T	TYPE D'ARTICLE	CODE	PRIX
1	120	55	35	45	Gros secteur	DDK72079	€ 495,00
2	120	54	35	45	Medium segmented	DDK75466	€ 495,00
3	120	54	35	40	Couronne continue fine	DDK75467	€ 606,00

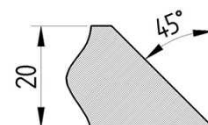

Meule de pré découpe

H	T	D	ID	TYPE D'ARTICLE	CODE	PRIX
35	42	120	70	Gros secteur	DDK75232	€ 470,00
35	45	120	55	Gros secteur	DDK72079	€ 495,00

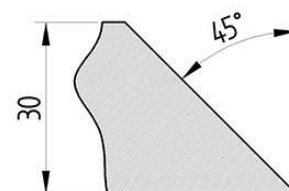

PLAN DU TRAVAIL

Forêt pour lavabo attache 1/2"

D	L	L1	RPM	AVANCE mm/min	CODE	PRIX
10	75	40	6000-7000	600-800	DDKFCR00010GW3,5	€ 144,00
15	75	40	6000-7000	600-800	DDKFCR00015GW3,5	€ 153,00
20	75	40	6000-7000	600-800	DDKFCR00020GW3,5	€ 162,00

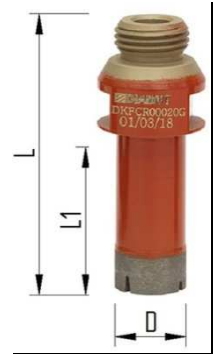

Meule attache 1/2" pour façonner l'intérieur de cuve



Parametres de travail:

POS	RPM	AVANCE mm/min	ENLEVEMENT (mm)	POUSSÉE ADAPTATIVE
1	7000-8000	800-1000	1 max	
2	7000-8000	700-800	0,5	
3	7000-8000	700-800	0,2-0,3	
4	4000-4500	1000		5-6
5	4000-4500	1000		5-6
6	4000-4500	1000		5-6

Pour epaisseur 20 mm

Z

POS	D	ID	H	T	TYPE D'ARTICLE	CODE	PRIX
1	20	20	1/2 GAS	25	Gros secteur	DDK10024	€ 160,00
2	20	20	1/2 GAS	25	Medium segmented	DDK10025	€ 260,00
3	20	20	1/2 GAS	25	Couronne continue fine	DDK10026	€ 260,00
4	20	20	1/2 GAS	25	Polissante	DLK31607	€ 150,00
5	20	20	1/2 GAS	25	Polissante	DLK31608	€ 150,00
6	20	20	5	25	Cerium	DLK31609	€ 17,00
6	5		1/2 GAS	108,5	Autre	DFR02508	€ 65,00

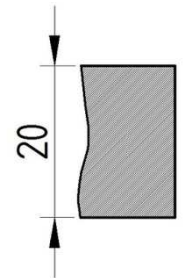

E

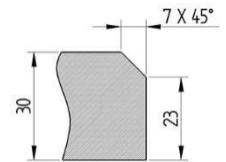
POS	D	ID	H	T	TYPE D'ARTICLE	CODE	PRIX
1	20	20	1/2 GAS	25	Gros secteur	DDK10024	€ 160,00
2	20	20	1/2 GAS	25	Medium segmented	DDK10025	€ 260,00
3	20	20	1/2 GAS	25	Couronne continue fine	DDK10026	€ 260,00
4	20	20	1/2 GAS	25	Polissante	DLK31607	€ 150,00
5	20	20	1/2 GAS	25	Polissante	DLK31608	€ 150,00
6	20	20	5	25	Cerium	DLK31609	€ 17,00
6	5		1/2 GAS	108,5	Autre	DFR02508	€ 65,00

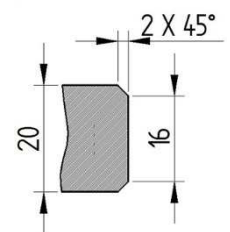

Profil trapezoidale

POS	D	ID	H	T	TYPE D'ARTICLE	CODE	PRIX
1	25	19	1/2 GAS	30	Couronne continue ebauche	DDK10032	€ 244,00
2	25	19	1/2 GAS	30	Couronne continue medium	DDK10033	€ 244,00
3	25	19	1/2 GAS	30	Couronne continue fine	DDK10034	€ 244,00
4	25	19	1/2 GAS	30	Polissante	DLK31699	€ 150,00
5	25	19	1/2 GAS	30	Polissante	DLK31700	€ 150,00
6	27	20	10	30	Cerium	DLK31701	€ 34,00
6	10		1/2 GAS	100	Autre	DFR02968	€ 170,00

E

POS	D	ID	H	T	TYPE D'ARTICLE	CODE	PRIX
1	25	19	1/2 GAS	30	Couronne continue ebauche	DDK10032	€ 244,00
2	25	19	1/2 GAS	30	Couronne continue medium	DDK10033	€ 244,00
3	25	19	1/2 GAS	30	Couronne continue fine	DDK10034	€ 244,00
4	25	19	1/2 GAS	30	Polissante	DLK31699	€ 150,00
5	25	19	1/2 GAS	30	Polissante	DLK31700	€ 150,00
6	27	20	10	30	Cerium	DLK31701	€ 34,00
6	10		1/2 GAS	100	Autre	DFR02968	€ 170,00

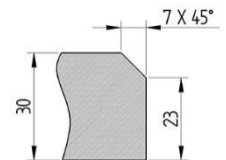

Pour epaisseur 30 mm

E

POS	D	ID	H	T	TYPE D'ARTICLE	CODE	PRIX
1	38	22	1/2 GAS	36	Gros secteur	DDK10021	€ 332,00
2	38	22	1/2 GAS	36	Medium segmented	DDK10022	€ 332,00
3	38	22	1/2 GAS	36	Couronne continue fine	DDK10023	€ 332,00
4	38	22	1/2 GAS	36	Polissante	DLK31096	€ 160,00
5	38	22	1/2 GAS	36	Polissante	DLK31097	€ 160,00
6	36	20	10	40	Cerium	DLK20091	€ 70,00
6	10		1/2 GAS	100	Autre	DFR02968	€ 170,00

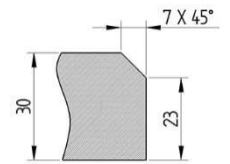

Z

POS	D	ID	H	T	TYPE D'ARTICLE	CODE	PRIX
1	20	20	1/2 GAS	45	Gros secteur	DDK10017	€ 170,00
2	20	20	1/2 GAS	45	Medium segmented	DDK10018	€ 170,00
3	20	20	1/2 GAS	45	Couronne continue fine	DDK10019	€ 284,00
4	20	20	1/2 GAS	45	Polissante	DLK30292	€ 150,00
5	20	20	1/2 GAS	45	Polissante	DLK30293	€ 150,00
6	20	20	5	50	Cerium	DLK20017	€ 28,00
6	5		1/2 GAS	108,5	Autre	DFR02508	€ 65,00

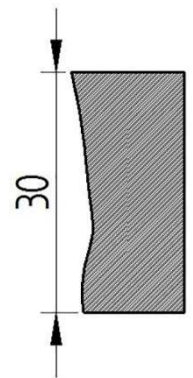

OUTILS POUR MATERIAUX SPECIAUX (*Ex: Chinaglass®, Laminam®, Whiteglass®, Kerlite®, Techlam®, Stoneglass®, Marmoglass®, ecc...)

* The manufacturers' names are used for identification purposes only. Diamut and Biesse Group have no ties of any nature with these companies.

Avec le terme synthétique cela veut dire matériel obtenu par mélange et concassage de différents matériaux dans la tranche, comme le silicone, quartz, aluminium ou autres, avec un haut niveau de pureté, assujetti à haut cycle de fabrication et hautes températures et pressions. Le but de ce process est d'obtenir chimiquement un liant entre les différentes particules des matériaux lesquels traduisent dans la production un bas niveau de porosité avec haute performance comme la couleur la stabilité dimensionnelle, la résistance mécanique, abrasivité, la chaleur, les éléments atmosphériques. grâce à cet habilité à produire différentes épaisseurs, cela garantit à ce matériel dans divers secteurs de la construction, fournitures, plan de travail, extérieur et intérieur de sol et plus en core....

FORÊTS

Forêt couronne continue attache 1/2" gas pour CNC

Longeur totale 95mm et longeur utile 50mm

D	L	L1	RPM	AVANCE mm/min	CODE	PRIX
10	95	50	2500-4000	15-25	DMTFGR000010	€ 59,00
15	95	50	2500-4000	15-25	DMTFGR000015	€ 63,00
18	95	50	2500-4000	15-25	DMTFGR000018	€ 65,00
20	95	50	2500-4000	15-25	DMTFGR000020	€ 75,00
22	95	50	1800-2500	15-25	DMTFGR000022	€ 75,00
25	95	50	1800-2500	15-25	DMTFGR000025	€ 84,00
30	95	50	1800-2500	15-25	DMTFGR000030	€ 90,00
32	95	50	2500-4000	15-25	DMTFGR000032	€ 98,00
35	95	50	1000-1800	15-25	DMTFGR000035	€ 105,00
40	95	50	1000-1800	15-25	DMTFGR000040	€ 120,00
70	95	50	1000-1300	15-25	DMTFGR000070	€ 135,00



FRAISE

Fraise a secteur attache 1/2" pour CNC

D	L1	Z	RPM	FEED mm/min	CODE	PRIX
10	27	4	4000	200	DMTFR02900	€ 140,00
16	25	5	6000-8000	350-600	DMTFR03038	€ 128,00
20	25	5	6000-8000	350-600	DMTFR10003	€ 128,00
22	35	5	6000-8000	350-600	DMTFR10002	€ 148,00

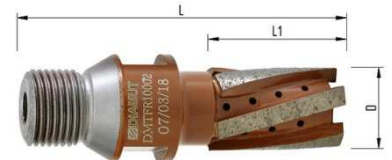

Fraise profil AR epaisseur 6mm

POS	D	ID	H	RPM	AVANCE mm/min	ENLEVEME NT mm	CODE	PRIX
1	20	15	1/2 GAS	8000-10000	450-600	1 max	DMTFR01561	€ 154,00
2	20	15	1/2 GAS	8000-10000	450-600	0,5	DMTFR01976	€ 154,00
3	20	15	1/2 GAS	8000-10000	450-600	0,2	DMTFR01572	€ 154,00



Fraise profil AR epaisseur 12mm

POS	D	ID	H	RPM	AVANCE mm/min	ENLEVEME NT mm	CODE	PRIX
1	20	16	1/2 GAS	8000-10000	450-600	1 max	DMTFR01381	€ 154,00
2	20	16	1/2 GAS	8000-10000	450-600	0,5	DMTFR01981	€ 154,00
3	20	16	1/2 GAS	8000-10000	450-600	0,2	DMTFR01642	€ 154,00



Fraise profil AR epaisseur 20mm

POS	D	ID	H	RPM	AVANCE mm/min	ENLEVEME NT mm	CODE	PRIX
1	20	15	1/2 GAS	8000-10000	450-600	1 max	DMTFR03029	€ 154,00
2	20	15	1/2 GAS	8000-10000	450-600	0,5	DMTFR03030	€ 154,00
3	20	15	1/2 GAS	8000-10000	450-600	0,2	DMTFR03031	€ 154,00



Fraise profil AK2 epaisseur 12mm

POS	D	ID	H	RPM	AVANCE mm/min	ENLEVEME NT mm	CODE	PRIX
1	20	14	1/2 GAS	8000-10000	450-600	1 max	DMTFR03039	€ 125,00
2	20	14	1/2 GAS	8000-10000	450-600	0,5	DMTFR03040	€ 125,00
3	20	14	1/2 GAS	8000-10000	450-600	0,2	DMTFR03041	€ 125,00



Fraise boisseau attache 1/2" gas pour CNC

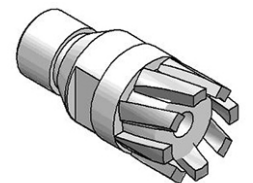

D	L1	Z	RPM	FEED mm/min	CODE	PRIX
30	20	5	6000-8000	350-600	DMTFR01651	€ 152,00

"Forêt pour lavabo attache 1/2""

D	L	L1	RPM	AVANCE mm/min	CODE	PRIX
10	75	40	6000-7000	600-800	DMTFCR00010GW3,5	€ 144,00
15	75	40	6000-7000	600-800	DMTFCR00015GW3,5	€ 153,00
20	75	40	6000-7000	600-800	DMTFCR00020GW3,5	€ 162,00



MEULE PERIPHERIQUE POUR SINTERED MATERIALS

Typologie meules diamantées pour CNC
Epaisseur 3mm – 6 mm – 8 mm – 10 mm



POS.3



POS.2



POS.1



POLISSANTE

POS.1	POS.2	POS.3	POS.4
1G	2M	3N	
MEULE DIAMANT A SECTEUR AVEC REFROIDISSEMENT INTERNE	MEULE COURONNE CONTINUE AVEC REFROIDISSEMENT INTERNE	MEULE COURONNE CONTINUE AVEC REFROIDISSEMENT INTERNE	POLISSANTE

Parametres de travail:

POS	D	RPM	FEED mm/min	ENLEVEMENT (mm)	POUSSÉE ADAPTATIVE
1	100	5000-6000	800-1000	1- 1,5	
2	100	5000-6000	1000-2000	0,3 - 0,6	
3	100	5000-6000	1000-2000	0,1-0,2	
4	100	3000-3500	1000 - 2000		3-6

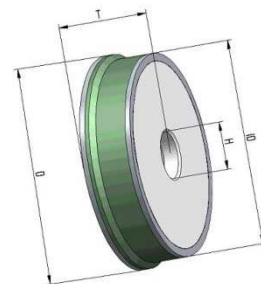

Pour epaisseur 3 mm

Profil trapezoidale

POS	H	T	D	ID	TYPE D'ARTICLE	CODE	PRIX
1	22	6	100	100	Gros secteur	DMTP02443	€ 166,00
2	22	14	100	94,5	Couronne continue medium	DMTTR06681	€ 175,00
3	22	14	100	94,5	Couronne continue fine	DMTTR06671	€ 175,00
4	22	15	100	100	Polissante	DMTL12010	€ 16,00

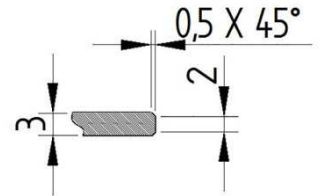

Pour epaisseur 6 mm

Profil trapezoidale

POS	H	T	D	ID	TYPE D'ARTICLE	CODE	PRIX
1	22	8	80	80	Gros secteur	DMTP02992	€ 190,00
2	22	16	80	74,8	Couronne continue medium	DMTTR07177	€ 244,00
3	22	16	80	74,8	Couronne continue fine	DMTTR07178	€ 244,00
4	22	15	100	100	Polissante	DMTL12010	€ 16,00

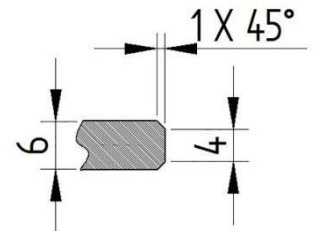

Profil trapezoidale

POS	H	T	D	ID	TYPE D'ARTICLE	CODE	PRIX
1	22	8	100	100	Gros secteur	DMTP01685	€ 182,00
2	22	20	100	94,6	Couronne continue medium	DMTTR06697	€ 200,00
3	22	20	100	94,6	Couronne continue fine	DMTTR00636	€ 200,00
4	22	15	100	100	Polissante	DMTL12010	€ 16,00

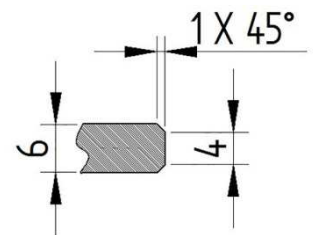

Pour épaisseur 8 mm

AK2

POS	H	T	D	ID	TYPE D'ARTICLE	CODE	PRIX
1	22	12	100	96	Gros secteur	DMTG02737	€ 215,00
2	22	20	100	96	Couronne continue medium	DMTG02110	€ 190,00
3	22	20	100	96	Couronne continue fine	DMTG06153	€ 190,00
4	22	15	100	100	Polissante	DMTL12010	€ 16,00

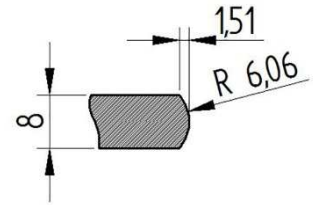

V

POS	H	T	D	ID	TYPE D'ARTICLE	CODE	PRIX
1	22	20	100	91	Gros secteur	DMTSP02815	€ 235,00
2	22	16	100	91	Couronne continue medium	DMTSP02369	€ 218,00
3	22	16	100	91	Couronne continue medium	DMTSP01325	€ 218,00
4	22	15	100	100	Polissante	DMTL12010	€ 16,00

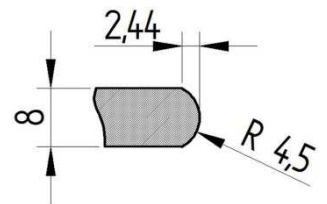

Trap

POS	H	T	D	ID	TYPE D'ARTICLE	CODE	PRIX
1	22	12	100	100	Gros secteur	DMTP01530	€ 184,00
2	22	20	100	94,9	Couronne continue medium	DMTTR06978	€ 180,00
3	22	20	100	94,9	Couronne continue fine	DMTTR02896	€ 180,00
4	22	15	100	100	Polissante	DMTL12010	€ 16,00

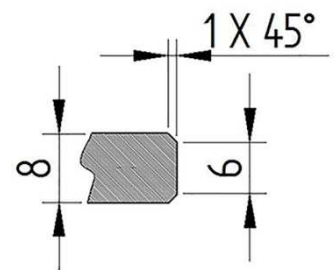

Pour epaisseur 10 mm

AK2

POS	H	T	D	ID	TYPE D'ARTICLE	CODE	PRIX
1	22	14	100	96,2	Gros secteur	DMTG07370	€ 215,00
2	22	20	100	96,2	Couronne continue medium	DMTG07371	€ 210,00
3	22	20	100	96,2	Couronne continue fine	DMTG07372	€ 210,00
4	22	20	100	100	Polissante	DMTL12014	€ 15,00

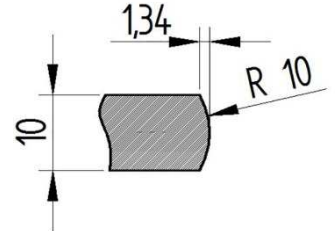

V

POS	H	T	D	ID	TYPE D'ARTICLE	CODE	PRIX
1	22	20	100	88,4	Gros secteur	DMTSP06764	€ 240,00
2	22	18	100	88,4	Couronne continue medium	DMTSP06765	€ 234,00
3	22	18	100	88,4	Couronne continue fine	DMTSP06766	€ 234,00
4	22	20	100	100	Polissante	DMTL12014	€ 15,00

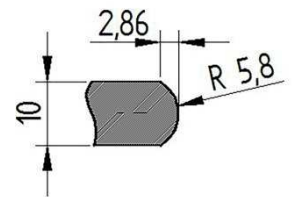

Profil trapezoidale

POS	H	T	D	ID	TYPE D'ARTICLE	CODE	PRIX
1	22	12	100	100	Gros secteur	DMTP01530	€ 184,00
2	22	20	100	94,6	Couronne continue medium	DMTTR00705	€ 190,00
3	22	20	100	94,6	Couronne continue fine	DMTTR00656	€ 190,00
4	22	20	100	100	Polissante	DMTL12014	€ 15,00

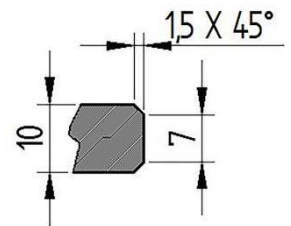

Typologie meules diamantées pour CNC

Epaisseur 12 mm – 15 mm – 20 mm



POS.1	POS.2	POS.3	POS.4	POS.5	POS.6
1B MEULE DIAMANT A SECTEUR AVEC REFROIDISSEMENT INTERNE	2H MEULE COURONNE CONTINUE AVEC REFROIDISSEMENT INTERNE	3N MEULE COURONNE CONTINUE AVEC REFROIDISSEMENT INTERNE	4R MEULE COURONNE CONTINUE AVEC REFROIDISSEMENT INTERNE	POLISSANTE	POLISSANTE

Parametres de travail:

POS	D	RPM	AVANCE mm/min	ENLEVEMENT (mm)
1	80	5000-5500	800-900	1,5-2
2	80	5000-5500	800-1000	0,5-0,6
3	80	5000-5500	800-1000	0,2-0,3
4	80	5000-5500	800-1000	0,1
5	80	2700	1000-1500	0,05
6	80	2700	1000-1500	0,05

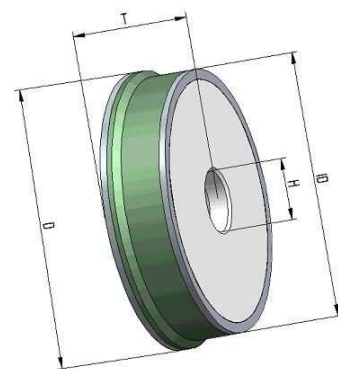

Pour epaisseur 12 mm

AK2

POS	H	T	D	ID	TYPE D'ARTICLE	CODE	PRIX
1	22	16	100	95,2	Gros secteur	DMTG07373	€ 235,00
2	22	24	100	95,2	Couronne continue ebauche	DMTG07374	€ 225,00
3	22	24	100	95,2	Couronne continue medium	DMTG07375	€ 225,00
4	22	24	100	95,2	Couronne continue fine	DMTG07489	€ 225,00
5	22	32	65	60	Polissante	DMTLG61713	€ 190,00
6	22	32	65	60	Polissante	DMTLG61714	€ 190,00

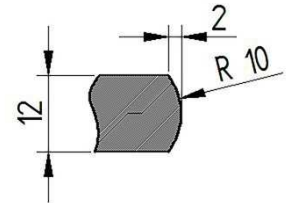

AF

POS	H	T	D	ID	TYPE D'ARTICLE	CODE	PRIX
1	22	20	100	94	Gros secteur	DMTSP06714	€ 235,00
2	22	21	100	94	Couronne continue ebauche	DMTSP06715	€ 230,00
3	22	21	100	94	Couronne continue medium	DMTSP06716	€ 230,00
4	22	21	100	94	Couronne continue fine	DMTSP07037	€ 230,00
5	22	32	66	60	Polissante	DMTLG61715	€ 190,00
6	22	32	66	60	Polissante	DMTLG61716	€ 190,00

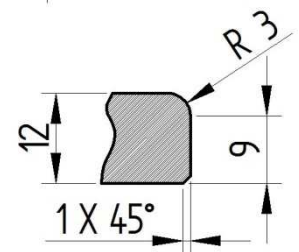

EF

POS	H	T	D	ID	TYPE D'ARTICLE	CODE	PRIX
1	22	24	100	82	Gros secteur	DMTSP01795	€ 369,00
2	22	21	100	88	Couronne continue ebauche	DMTSP01793	€ 285,00
3	22	21	100	88	Couronne continue medium	DMTSP01794	€ 285,00
4	22	21	100	88	Couronne continue fine	DMTSP07039	€ 285,00
5	22	32	72	60	Polissante	DMTLG61719	€ 190,00
6	22	32	72	60	Polissante	DMTLG61720	€ 190,00

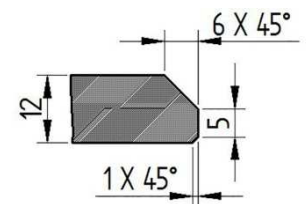

T

POS	H	T	D	ID	TYPE D'ARTICLE	CODE	PRIX
1	22	16	100	94	Gros secteur	DMTSP06777	€ 273,00
2	22	24	100	94	Couronne continue ebauche	DMTSP06722	€ 280,00
3	22	24	100	94	Couronne continue medium	DMTSP06723	€ 280,00
4	22	24	100	94	Couronne continue fine	DMTSP07040	€ 205,00
5	22	32	70	60	Polissante	DMTLG61721	€ 190,00
6	22	32	70	60	Polissante	DMTLG61722	€ 190,00

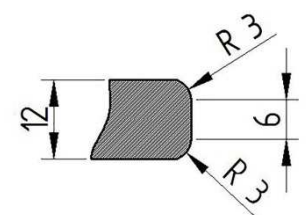

Profil trapezoidale

POS	H	T	D	ID	TYPE D'ARTICLE	CODE	PRIX
1	22	15	80	80	Gros secteur	DMTP08085	€ 208,00
2	22	21	80	74,8	Couronne continue ebauche	DMTTR07227	€ 265,00
3	22	21	80	74,8	Couronne continue medium	DMTTR07228	€ 265,00
4	22	21	80	75	Couronne continue fine	DMTTR07446	€ 265,00
5	22	32	65	60	Polissante	DMTLG61723	€ 190,00
6	22	32	65	60	Polissante	DMTLG61724	€ 190,00

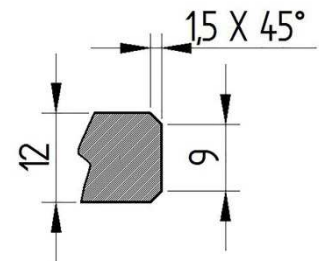

V

POS	H	T	D	ID	TYPE D'ARTICLE	CODE	PRIX
1	22	20	100	87	Gros secteur	DMTSP01801	€ 240,00
2	22	20	100	87	Couronne continue ebauche	DMTSP06672	€ 260,00
3	22	20	100	87	Couronne continue medium	DMTSP01802	€ 260,00
4	22	20	100	87	Couronne continue fine	DMTSP07041	€ 260,00
5	22	32	73	60	Polissante	DMTLG61726	€ 190,00
6	22	32	73	60	Polissante	DMTLG61727	€ 190,00

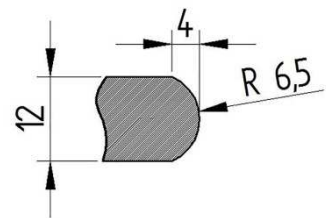

Pour epaisseur 15 mm

E

POS	H	T	D	ID	TYPE D'ARTICLE	CODE	PRIX
1	22	17	100	100	Gros secteur	DMTP06591	€ 189,00
2	22	24	100	95	Couronne continue medium	DMTSP06775	€ 215,00
3	22	24	100	95	Couronne continue medium	DMTSP06776	€ 215,00
4	22	24	100	95	Couronne continue fine	DMTSP07038	€ 215,00
5	22	32	65	60	Polissante	DMTLG61717	€ 190,00
6	22	32	65	60	Polissante	DMTLG61718	€ 190,00

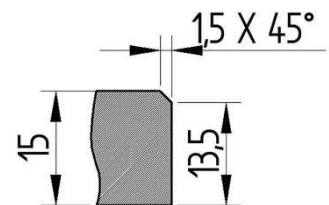

Profil trapezoidale

POS	H	T	D	ID	TYPE D'ARTICLE	CODE	PRIX
1	22	17	80	80	Gros secteur	DMTP08086	€ 217,00
2	22	24	80	74,8	Couronne continue medium	DMTTR07229	€ 241,00
3	22	24	80	74,8	Couronne continue medium	DMTTR07230	€ 241,00
4	22	24	80	75	Couronne continue fine	DMTTR07445	€ 241,00
5	22	32	65	60	Polissante	DMTLG61711	€ 190,00
6	22	32	65	60	Polissante	DMTLG61712	€ 190,00

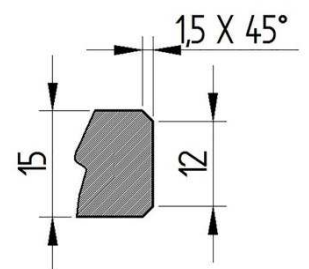

Pour epaisseur 20 mm

A

POS	H	T	D	ID	TYPE D'ARTICLE	CODE	PRIX
1	35	33	80	66	Gros secteur	DMTGS82291	€ 318,00
2	35	32	80	66	Couronne continue ebauche	DMTGS82292	€ 318,00
3	35	32	80	66	Couronne continue medium	DMTGS82293	€ 318,00
4	35	32	80	66	Couronne continue fine	DMTGS82294	€ 318,00
5	35	42	71	60	Polissante	DMTLG60767	€ 173,00
6	35	42	71	60	Polissante	DMTLG60768	€ 173,00

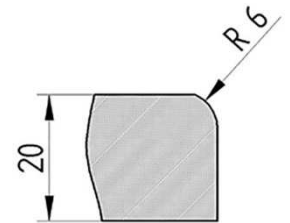

A

POS	H	T	D	ID	TYPE D'ARTICLE	CODE	PRIX
1	35	60	80	60	Gros secteur	DMTGS74440	€ 318,00
2	35	60	80	60	Couronne continue ebauche	DMTGS74082	€ 318,00
3	35	60	80	60	Couronne continue medium	DMTGS74083	€ 318,00
4	35	60	80	60	Couronne continue fine	DMTGS74084	€ 318,00
5	35	60	80	60	Polissante	DMTLG60280	€ 173,00
6	35	60	80	60	Polissante	DMTLG60281	€ 173,00

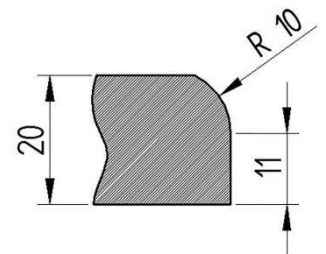

AFR

POS	H	T	D	ID	TYPE D'ARTICLE	CODE	PRIX
1	35	33	80	66	Gros secteur	DMTGS82291	€ 318,00
2	35	32	80	66	Couronne continue ebauche	DMTGS83792	€ 318,00
3	35	32	80	66	Couronne continue medium	DMTGS83793	€ 318,00
4	35	32	80	66	Couronne continue fine	DMTGS83794	€ 318,00
5	35	42	73	60	Polissante	DMTLG61589	€ 196,00
6	35	42	73	60	Polissante	DMTLG61590	€ 196,00

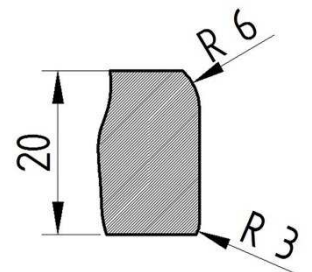

AFR

POS	H	T	D	ID	TYPE D'ARTICLE	CODE	PRIX
1	35	60	80	60	Gros secteur	DMTGS74440	€ 318,00
2	35	32	80	60	Couronne continue ebauche	DMTGS81223	€ 335,00
3	35	32	80	60	Couronne continue medium	DMTGS81224	€ 335,00
4	35	32	80	60	Couronne continue fine	DMTGS81225	€ 335,00
5	35	32	80	60	Polissante	DMTLG61475	€ 196,00
6	35	32	80	60	Polissante	DMTLG61476	€ 196,00

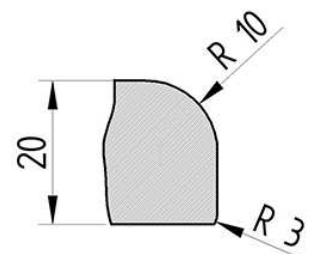

AK2

POS	H	T	D	ID	TYPE D'ARTICLE	CODE	PRIX
1	35	28	80	73	Gros secteur	DMTGS82444	€ 306,00
2	35	32	80	73	Couronne continue ebauche	DMTGS82445	€ 371,00
3	35	32	80	73	Couronne continue medium	DMTGS82446	€ 371,00
4	35	32	80	73	Couronne continue fine	DMTGS82447	€ 371,00
5	35	42	68	60	Polissante	DMTLG60896	€ 173,00
6	35	42	68	60	Polissante	DMTLG60897	€ 173,00

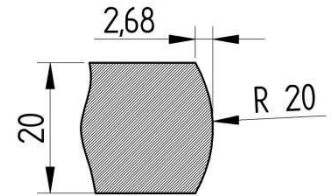
E

POS	H	T	D	ID	TYPE D'ARTICLE	CODE	PRIX
1	35	32	80	64	Gros secteur	DMTGS82304	€ 318,00
2	35	31	80	64	Couronne continue ebauche	DMTGS82305	€ 318,00
3	35	31	80	64	Couronne continue medium	DMTGS82306	€ 318,00
4	35	31	80	64	Couronne continue fine	DMTGS82307	€ 318,00
5	35	42	76	60	Polissante	DMTLG60803	€ 173,00
6	35	42	76	60	Polissante	DMTLG60804	€ 173,00

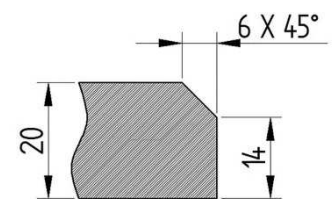
T

POS	H	T	D	ID	TYPE D'ARTICLE	CODE	PRIX
1	35	32	80	64	Gros secteur	DMTGS83964	€ 325,00
2	35	32	80	72	Couronne continue ebauche	DMTGS74431	€ 358,00
3	35	32	80	72	Couronne continue medium	DMTGS74432	€ 358,00
4	35	32	80	72	Couronne continue fine	DMTGS74433	€ 358,00
5	35	42	67	60	Polissante	DMTLG60006	€ 172,00
6	35	42	67	60	Polissante	DMTLG60007	€ 172,00

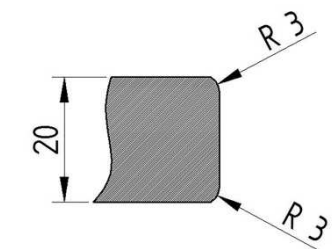

T

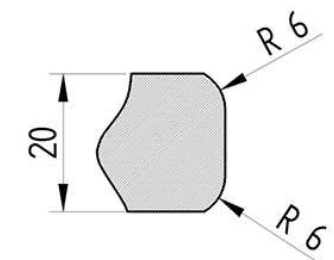
POS	H	T	D	ID	TYPE D'ARTICLE	CODE	PRIX
1	35	32	80	63	Gros secteur	DMTGS81056	€ 348,00
2	35	23	80	63	Couronne continue ebauche	DMTGS81057	€ 420,00
3	35	23	80	63	Couronne continue medium	DMTGS81058	€ 420,00
4	35	23	80	63	Couronne continue fine	DMTGS81059	€ 420,00
5	35	42	76	60	Polissante	DMTLG61142	€ 173,00
6	35	42	76	60	Polissante	DMTLG61143	€ 173,00

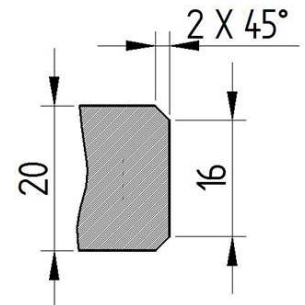

Profil trapezoidale

POS	H	T	D	ID	TYPE D'ARTICLE	CODE	PRIX
1	35	24	80	80	Gros secteur	DMTGS74430	€ 386,00
2	35	32	80	72	Couronne continue ebauche	DMTGS77752	€ 375,00
3	35	32	80	72	Couronne continue medium	DMTGS77753	€ 375,00
4	35	32	80	72	Couronne continue fine	DMTGS77754	€ 375,00
5	35	42	67	60	Polissante	DMTLG61426	€ 196,00
6	35	42	67	60	Polissante	DMTLG61427	€ 196,00



Profil trapezoidale

POS	H	T	D	ID	TYPE D'ARTICLE	CODE	PRIX
1	35	24	80	80	Gros secteur	DMTGS74430	€ 386,00
2	35	32	80	72	Couronne continue ebauche	DMTGS81414	€ 375,00
3	35	32	80	72	Couronne continue medium	DMTGS81415	€ 375,00
4	35	32	80	72	Couronne continue fine	DMTGS81416	€ 375,00
5	35	52	67	60	Polissante	DMTLG60142	€ 192,00
6	35	52	67	60	Polissante	DMTLG60143	€ 192,00

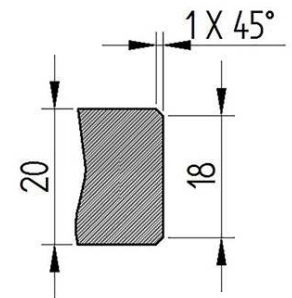

ZK107

POS	H	T	D	ID	TYPE D'ARTICLE	CODE	PRIX
1	35	32	80	68	Gros secteur	DMTGS83945	€ 380,00
2	35	32	80	68	Couronne continue ebauche	DMTGS83946	€ 430,00
3	35	32	80	68	Couronne continue medium	DMTGS83947	€ 430,00
4	35	32	80	68	Couronne continue fine	DMTGS83948	€ 430,00
5	35	32	71	60	Polissante	DMTLG61666	€ 196,00
6	35	32	71	60	Polissante	DMTLG61667	€ 196,00

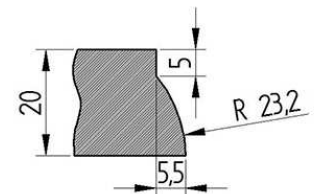

Meule pour profil 45°

Jusqu' à 15 mm

POS	H	T	D	ID	TYPE D'ARTICLE	CODE	PRIX
1	22	18	100	64	Gros secteur	DMTSM06292	€ 259,00
2	22	25	100	62	Couronne continue medium	DMTSM06302	€ 273,00
3	22	25	100	62	Couronne continue fine	DMTSM06291	€ 273,00

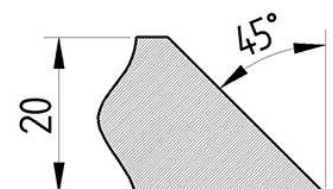

Meule d'ébauche corner breakers

H	T	D	ID	TYPE D'ARTICLE	CODE	PRIX
22	18	100	64	Gros secteur	DMTSM06292	€ 259,00
22	27	100	35	Gros secteur	DMTSM00849	€ 250,00

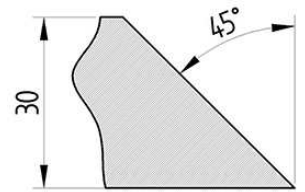

PLAN DU TRAVAIL

Fraise pour cannelures attache 1/2" pour CNC

POS	D	R	H	GRAIN	RPM	AVANCE mm/min	ENLEVEMENT mm	CODE	PRIX
1	14	6,3	1/2 GAS	D252	5000-6000	300-400	A profilo / To profile	DMTFR10005	€ 106,00
2	14	6,8	1/2 GAS	D64	5000-6000	300-400	0,3max	DMTFR10006	€ 106,00
3	14	7	1/2 GAS	D46	5000-6000	300-400	0-0,05	DMTFR10007	€ 106,00

Meule attache 1/2" pour façonner l'intérieur de cuve

Parametres de travail:

POS	RPM	AVANCE mm/min	ENLEVEMENT (mm)
1	5500-6000	800-1000	1
2	5500-6000	800-1000	0,3
3	5500-6000	800-1000	0,2
4	5500-6000	800-1000	0,1
5	2500-2800	800-1000	0,05
6	2500-2800	800-1000	0,05

Pour epaisseur 12mm

Profil trapezoidale

POS	D	ID	H	TYPE D'ARTICLE	CODE	PRIX
1	25	20	1/2 GAS	Gros secteur	DMTGG83298	€ 180,00
2	25	20	1/2 GAS	Couronne continue ebauche	DMTGG80584	€ 180,00
3	25	20	1/2 GAS	Couronne continue medium	DMTGG80585	€ 180,00
4	25	20	1/2 GAS	Couronne continue fine	DMTGG80586	€ 180,00
5	25	20	1/2 GAS	Polissante	DMTLG61309	€ 150,00
6	25	20	1/2 GAS	Polissante	DMTLG61310	€ 150,00

PRIX TOTAL DU SET:1.020,00 €

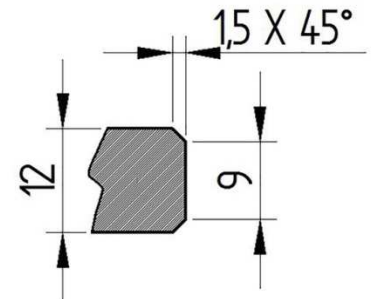

Pour epaisseur 20 mm

A

POS	D	ID	H	TYPE D'ARTICLE	CODE	PRIX
1	38	21,5	1/2 GAS	Gros secteur	DMTGG83660	€ 180,00
2	38	21,5	1/2 GAS	Couronne continue ebauche	DMTGG83661	€ 180,00
3	38	21,5	1/2 GAS	Couronne continue medium	DMTGG83662	€ 180,00
4	38	21,5	1/2 GAS	Couronne continue fine	DMTGG83663	€ 180,00
5	38	21,5	1/2 GAS	Polissante	DMTLG61514	€ 150,00
6	38	21,5	1/2 GAS	Polissante	DMTLG61515	€ 150,00

PRIX TOTAL DU SET:1.020,00 €

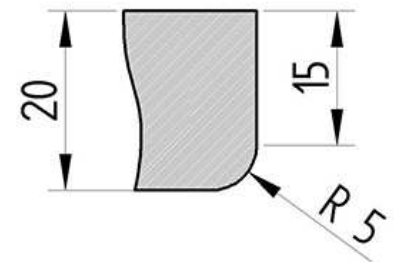

E

POS	D	ID	H	TYPE D'ARTICLE	CODE	PRIX
1	38	21,5	1/2 GAS	Gros secteur	DMTGG83703	€ 180,00
2	38	21,5	1/2 GAS	Couronne continue ebauche	DMTGG83704	€ 180,00
3	38	21,5	1/2 GAS	Couronne continue medium	DMTGG83705	€ 180,00
4	38	21,5	1/2 GAS	Couronne continue fine	DMTGG83706	€ 180,00
5	38	21,5	1/2 GAS	Polissante	DMTLG61552	€ 150,00
6	38	21,5	1/2 GAS	Polissante	DMTLG61553	€ 150,00

PRIX TOTAL DU SET:1.020,00 €

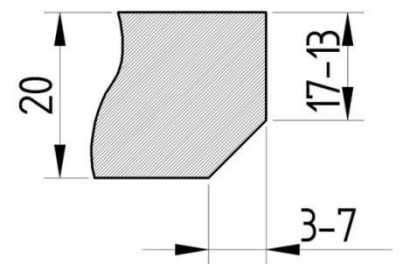

E

POS	D	ID	H	TYPE D'ARTICLE	CODE	PRIX
1	38	21,5	1/2 GAS	Gros secteur	DMTGG83783	€ 180,00
2	38	21,5	1/2 GAS	Couronne continue ebauche	DMTGG83784	€ 180,00
3	38	21,5	1/2 GAS	Couronne continue medium	DMTGG83786	€ 180,00
4	38	21,5	1/2 GAS	Couronne continue fine	DMTGG83787	€ 180,00
5	38	21,5	1/2 GAS	Polissante	DMTLG61583	€ 150,00
6	38	21,5	1/2 GAS	Polissante	DMTLG61584	€ 150,00

PRIX TOTAL DU SET:1.020,00 €

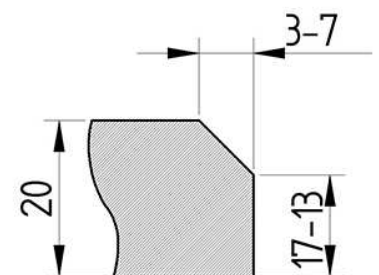

T

POS	D	ID	H	TYPE D'ARTICLE	CODE	PRIX
1	25	17,9	1/2 GAS	Gros secteur	DMTGG83902	€ 180,00
2	25	17,9	1/2 GAS	Couronne continue ebauche	DMTGG80297	€ 180,00
3	25	17,9	1/2 GAS	Couronne continue medium	DMTGG80298	€ 180,00
4	25	17,9	1/2 GAS	Couronne continue fine	DMTGG80299	€ 180,00
5	25	17,9	1/2 GAS	Polissante	DMTLG60106	€ 150,00
6	25	17,9	1/2 GAS	Polissante	DMTLG60107	€ 150,00

PRIX TOTAL DU SET:1.020,00 €

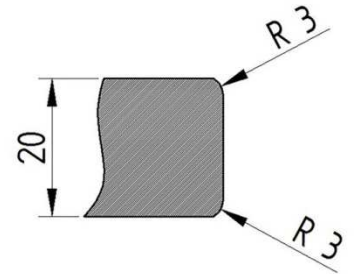
Profil trapezoidale

POS	D	ID	H	TYPE D'ARTICLE	CODE	PRIX
1	25	21	1/2 GAS	Gros secteur	DMTGG81512	€ 180,00
2	25	21	1/2 GAS	Couronne continue ebauche	DMTGG81513	€ 180,00
3	25	21	1/2 GAS	Couronne continue medium	DMTGG81514	€ 180,00
4	25	21	1/2 GAS	Couronne continue fine	DMTGG81515	€ 180,00
5	25	21	1/2 GAS	Polissante	DMTLG60382	€ 150,00
6	25	21	1/2 GAS	Polissante	DMTLG60383	€ 150,00

PRIX TOTAL DU SET:1.020,00 €

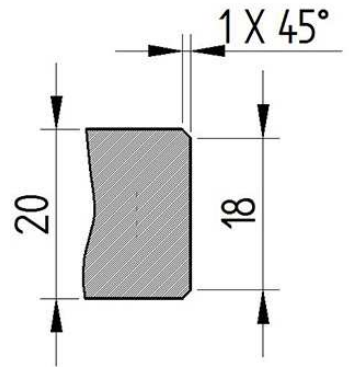

OUTILS POUR BISEAUX POUR CNC



POS. 1-2



POS. 2-3-4-5-6-7-8

5 axes - V 0 Intermac

POS	D	H	TYPE D'ARTICLE	GRAIN	RPM	AVANCE mm/min	CODE	PRIX
1	150	22	Gros secteur	D301	3500	800	DMTTB00299	€ 200,00
2	150	22	Couronne continue medium	D107	3500	800	DMTTB00300	€ 200,00
3	150	22	Resine	D46	3500	700	DMTTB00301	€ 190,00
4	150	22	Resine	600	5000	500-650	DMTTB00209	€ 190,00
5	150	22	Resine	800	5000	500-650	DMTTB00210	€ 190,00
6	150	22	Resine	1000	3500	500	DMTTB00211	€ 190,00
7	150	22	Resine	3000	3500	500	DMTTB00213	€ 190,00

PIERRE DE POMPE POUR REVIVRE

DIMENSIONS	NOTE	CODE	PRIX
150X50X16	Grane grosse / Rough grit	D9040	€ 6,00
200x90x35	Grane medio-grosse / Medium and Rough grit	D9401	€ 22,00
90x60x60	Grane fini / Fine grit	D9900	€ 8,00

Les pierre de ravnivage pour meules forets et disques

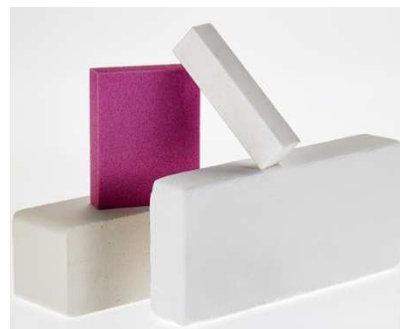

This price list serves to cancel out and replace any quotes in your possession, in any established and applied form. Diamut reserves the right to make changes to this document at any time, without prior notice. The prices shown always refer to the individual cost, do not include taxes and are intended to be understood as ex-works prices. Prices may be subject to variation over the course of the year, always check the price indicated on the order confirmation

MS_vers_001 17/01/2020